

Science 6

Guide

Website References

Website references contained within this document are provided solely as a convenience and do not constitute an endorsement by the Department of Education of the content, policies, or products of the referenced website. The department does not control the referenced websites and subsequent links, and is not responsible for the accuracy, legality, or content of those websites. Referenced website content may change without notice.

Regional Education Centres and educators are required under the Department's Public School Programs Network Access and Use Policy to preview and evaluate sites before recommending them for student use. If an outdated or inappropriate site is found, please report it to <curriculum@novascotia.ca>.

Science 6

© Crown copyright, Province of Nova Scotia, 2008, 2019

Prepared by the Department of Education and Early Childhood Development

This is the most recent version of the current curriculum materials as used by teachers in Nova Scotia.

The contents of this publication may be reproduced in part provided the intended use is for non-commercial purposes and full acknowledgment is given to the Nova Scotia Department of Education.

Atlantic Canada Science Curriculum



Science Grade 6

S

CURRICULUM

**Atlantic Canada Science Curriculum:
Grade 6**

Website References

Website references contained within this document are provided solely as a convenience and do not constitute an endorsement by the Department of Education of the content, policies, or products of the referenced website. The department does not control the referenced websites and subsequent links and is not responsible for the accuracy, legality, or content of those websites. Referenced website content may change without notice.

School boards and educators are required under the department's Public School Programs' Network Access and Use Policy to preview and evaluate sites before recommending them for student use. If an outdated or inappropriate site is found, please report it to links@EDnet.ns.ca.

Atlantic Canada Science Curriculum: Grade 6

© Crown Copyright, Province of Nova Scotia 2008
Prepared by the Department of Education

Contents of this publication may be reproduced in whole or in part provided the intended use is for non-commercial purposes and full acknowledgment is given to the Nova Scotia Department of Education.

Cataloguing-in-Publication Data

Main entry under title.

Atlantic Canada science curriculum: Grade Six/
Nova Scotia. Department of Education.

ISBN: 978-1-55457-252-6

1. Science - Study and teaching - Handbooks, manuals, etc.
2. Science - Nova Scotia - Handbooks, manuals, etc. I. Nova Scotia.
Department of Education.

507 - dc 22

2008

Foreword

The pan-Canadian *Common Framework of Science Learning Outcomes K to 12* (1997) provides the basis for the curriculum described in *Foundation for the Atlantic Canada Science Curriculum* (1998) and in guides for grades Primary–10 science.

Science 6 includes the following units:

- Life Science: Diversity of Life
- Physical Science: Electricity
- Physical Science: Flight
- Earth and Space Science: Space

This guide is intended to provide teachers with the outcomes framework for the course. It also includes some suggestions to assist teachers in designing learning experiences and assessment tasks.

Acknowledgments

The Council of Atlantic Ministers of Education and Training, formerly the Atlantic Provinces Education Foundation, expresses its indebtedness to members of the regional science committees for their professional expertise and insights in developing this regional science curriculum guide. In addition, pilot teachers and others who contributed comments and suggestions are commended for their commitment to developing exemplary science programs.

Contents

Introduction	Background	1
	Aim	1
Program Design and Components	Learning and Teaching Science	3
	The Science Lesson—Links to the World	4
	Writing in Science	5
	The Three Processes of Scientific Literacy	6
	Meeting the Needs of All Learners	7
	Assessment and Evaluation	8
	Instructional Time	8
Curriculum Outcomes Framework	Overview	9
	Essential Graduation Learnings	10
	General Curriculum Outcomes	11
	Key-Stage Curriculum Outcomes	11
	Specific Curriculum Outcomes	11
	Attitudes Outcomes	16
	Curriculum Guide Organization	19
	Unit Organization	19
	The Four-Column Spread	20
	Physical Science: Electricity	Introduction
Focus and Context		24
Science Curriculum Links		24
Curriculum Outcomes		25
Physical Science: Flight	Introduction	38
	Focus and Context	38
	Science Curriculum Links	38
	Curriculum Outcomes	39
Earth and Space Science: Space	Introduction	50
	Focus and Context	50
	Science Curriculum Links	50
	Curriculum Outcomes	51
Life Science: Diversity of Life	Introduction	64
	Focus and Context	64
	Science Curriculum Links	64
	Curriculum Outcomes	65

Appendices

Appendix A: Equipment Lists	77
Appendix B: Video Resources	83
Appendix C: Performance Assessment	87
Appendix D: Journals and Logbooks	89
Appendices E–H	93
Appendix E: Activities for Physical Science: Electricity	95
Appendix F: Activities for Physical Science: Flight	123
Appendix G: Activities for Earth and Space Science: Space	141
Appendix H: Activities for Life Science: Diversity of Life	165
Appendix I: Print Resources	187
Appendix J: Pan-Canadian Outcomes Chart	189

Introduction

Background

The curriculum described in *Foundation for the Atlantic Canada Science Curriculum* and related curriculum guides was planned and developed collaboratively by regional committees. The process for developing the common science curriculum for Atlantic Canada involved regional consultation with the stakeholders in the education system in each Atlantic province. The Atlantic Canada science curriculum is consistent with the framework described in the pan-Canadian *Common Framework of Science Learning Outcomes K to 12*.

Aim

The aim of science education in the Atlantic provinces is to develop scientific literacy.

Scientific literacy is an evolving combination of the science-related attitudes, skills, and knowledge that students need to develop inquiry, problem-solving, and decision-making abilities; to become lifelong learners; and to maintain a sense of wonder about the world around them. To develop scientific literacy, students require diverse learning experiences that provide opportunities to explore, analyse, evaluate, synthesize, appreciate, and understand the interrelationships among science, technology, society, and the environment.

Program Design and Components

Learning and Teaching Science

What students learn is fundamentally connected to how they learn it. The aim of scientific literacy for all has created a need for new forms of classroom organization, communication, and instructional strategies. The teacher is a facilitator of learning whose major tasks include

- creating a classroom environment to support the learning and teaching of science
- designing effective learning experiences that help students achieve designated outcomes
- stimulating and managing classroom discourse in support of student learning
- learning about and then using students' motivations, interests, abilities, and learning styles to improve learning and teaching
- assessing student learning, the scientific tasks and activities involved, and the learning environment to make ongoing instructional decisions
- selecting teaching strategies from a wide repertoire

Effective science learning and teaching take place in a variety of situations. Instructional settings and strategies should create an environment that reflects a constructive, active view of the learning process. Learning occurs through actively constructing one's own meaning and assimilating new information to develop a new understanding.

The development of scientific literacy in students is a function of the kinds of tasks in which they engage, the discourse in which they participate, and the settings in which these activities occur. Students' disposition toward science is also shaped by these factors. Consequently, the aim of developing scientific literacy requires careful attention to all of these facets of curriculum.

Learning experiences in science education should vary and should include opportunities for group and individual work; discussion among students as well as between teacher and students; and hands-on, minds-on activities that allow students to construct and evaluate explanations for the phenomena under investigation. Such investigations and the evaluation of the evidence accumulated provide opportunities for students to develop their understanding of the nature of science and the nature and status of scientific knowledge.

The Science Lesson—Links to the World

It is very important for children to learn through experiences in science. Students can engage in problem solving, decision making, and inquiry only through a hands-on approach to learning. Using their senses, and the power of observation, and recording their findings—in writing, by illustration, or verbally—are key to a meaningful experience and understanding.

Before starting a science activity, the teacher should take the time to engage students in dialogue on their prior knowledge of a topic and to record key vocabulary words and thoughts to be used as a reference as the activity progresses. The teacher should also articulate and discuss expectations for communication and teamwork with the students before they engage in any hands-on learning experiences that require them to be involved in groups.

During the lesson, the teacher should walk among the groups and listen, prompt discovery through questioning, and respond to the students' work. The teacher should act as a guide and support person to help students see themselves as capable and successful. This is an ideal opportunity to assess the students' ability to meet the outcomes through the activity being done. Assessment can be in the form of notes, check-off lists, sticky notes, or thoughts to be written down at a later time. Recording assessments during an activity is sometimes a challenge, as the teacher is managing the class as well as answering individual or group questions. Recording can be done during follow-up time or at a time more manageable for the teacher.

The follow-up to a lesson is crucial as it allows students the opportunity to communicate the ideas, discoveries, and questions that arise from engaging in a hands-on learning experience. This occurs when the results of the activity are pulled together and groups or individuals discuss with the whole class their findings from the activity. Additional vocabulary is often developed and should be recorded for future reference. Without follow-up to a lesson, an opportunity for students to achieve knowledge, skills, and attitudes outcomes can be missed. It is important to use this as a time for students to ask questions that might lead to exploration and investigation throughout the unit. Often the follow-up discussions will lead to further investigations to be done at another time.

Follow-up time can also be an ideal time to *link* other subject areas with science. This could include, for example, reflection upon prior activities in math (such as in measurement or data management), a shared or read-aloud experience related to the activity during language arts time, or an art activity. The science activity should not be an activity done for the sake of doing an activity. Discussion and links to other areas are key to students' continuing to view learning as an integrated whole.

Writing in Science

Learning experiences should provide opportunities for students to use writing and other forms of representation as ways of learning. Students at all grade levels should be encouraged to use writing to speculate, summarize, discover connections, describe processes, express understandings, raise questions, and make sense of new information by using their own language as a step to the language of science. Science logs are useful for such expressive and reflective writing. Purposeful note making is an intrinsic part of learning in science, helping students to better record, organize, and understand information from a variety of sources. The process of creating word webs, maps, charts, tables, graphs, drawings, and diagrams to represent data and results helps students learn and also provides them with useful study tools.

Learning experiences in science should also provide abundant opportunities for students to communicate their findings and understandings to others, both formally and informally, using a variety of forms for a range of purposes and audiences. Such experiences should encourage students to use effective ways of recording and conveying information and ideas and to use the vocabulary of science in expressing their understandings. Through opportunities to talk and write about the concepts they need to learn, students come to better understand both the concepts and related vocabulary.

Students will need explicit instruction in, and demonstration of, the strategies they need to develop and apply in reading, viewing, interpreting, and using a range of science texts for various purposes. It will be equally important for students to have demonstrations of the strategies they need to develop and apply in selecting, constructing, and using various forms for communication in science.

The Three Processes of Scientific Literacy

An individual can be considered scientifically literate when he/she is familiar with, and able to engage in, three processes: inquiry, problem solving, and decision making.

Inquiry

Scientific inquiry involves posing questions and developing explanations for phenomena. While there is general agreement that there is no such thing as the scientific method, students require certain skills to participate in the activities of science. Skills such as questioning, observing, inferring, predicting, measuring, hypothesizing, classifying, designing experiments, collecting data, analysing data, and interpreting data are fundamental to engaging in science. These activities provide students with opportunities to understand and practise the process of theory development in science and the nature of science.

Problem Solving

The process of problem solving involves seeking solutions to human problems. It consists of proposing, creating, and testing prototypes, products, and techniques to determine the best solution for a given problem.

Decision Making

The process of decision making involves determining what we, as citizens, should do in a particular context or in response to a given situation. Decision-making situations are important in their own right, and they also provide a relevant context for engaging in scientific inquiry and/or problem solving.

Meeting the Needs of All Learners

Foundation for the Atlantic Canada Science Curriculum stresses the need to design and implement a science curriculum that provides equitable opportunities for all students according to their abilities, needs, and interests. Teachers must be aware of, and make adaptations to accommodate, the needs of the diverse range of learners in their classes. To adapt instructional strategies, assessment practices, and learning resources to the needs of all learners, teachers must create opportunities that will permit them to address their students' various learning styles.

As well, teachers must not only remain aware of and avoid gender and cultural biases in their teaching, they must also actively address cultural and gender stereotyping (e.g., stereotypes about who is interested in and who can succeed in science). Research supports the position that when science curriculum is made personally meaningful and socially and culturally relevant, it is more engaging for groups traditionally under-represented in science and, indeed, for all students.

While this curriculum guide presents specific outcomes for each unit, it must be acknowledged that students will progress at different rates.

Teachers should provide materials and strategies that accommodate student diversity and should validate students when they achieve the outcomes to the best of their abilities.

It is important that teachers articulate high expectations for all students and ensure that all students have equitable opportunities to experience success as they work toward achieving designated outcomes. Teachers should adapt classroom organization, teaching strategies, assessment practices, time, and learning resources to address students' needs and build on their strengths. The variety of learning experiences described in this guide provides access for a wide range of learners. Similarly, the suggestions for a variety of assessment practices provide multiple ways for learners to demonstrate their achievements.

Assessment and Evaluation

The terms **assessment** and **evaluation** are often used interchangeably, but they refer to quite different processes. Science curriculum documents developed in the Atlantic region use these terms for the processes described below.

Assessment is the systematic process of gathering information on student learning.

Evaluation is the process of analysing, reflecting upon, and summarizing assessment information and making judgments or decisions based upon the information gathered.

The assessment process provides the data, and the evaluation process brings meaning to the data. Together, these processes improve teaching and learning. If we are to encourage enjoyment in learning for students now and throughout their lives, we must develop strategies to involve students in assessment and evaluation at all levels. When students are aware of the outcomes for which they are responsible and of the criteria by which their work will be assessed or evaluated, they can make informed decisions about the most effective ways to demonstrate their learning.

The Atlantic Canada science curriculum reflects the three major processes of science learning: inquiry, problem solving, and decision making. When assessing student progress, it is helpful to know some activities/skills/actions that are associated with each process of science learning. Student learning may be described in terms of the ability to perform these tasks.

Instructional Time

It is expected that a minimum of 110 minutes per week will be the allotment of instructional time for Science 6 curriculum. In addition, there are many opportunities to address science curriculum outcomes in the context of other subject areas in the elementary program, such as health education, language arts, mathematics, music, social studies, and visual arts.

Curriculum Outcomes Framework

Overview

The science curriculum is based on an outcomes framework that includes statements of essential graduation learnings, general curriculum outcomes, key-stage curriculum outcomes, and specific curriculum outcomes. The general, key-stage, and specific curriculum outcomes reflect the pan-Canadian *Common Framework of Science Learning Outcomes K to 12*. The diagram below provides the blueprint of the outcomes framework.

Outcomes Framework

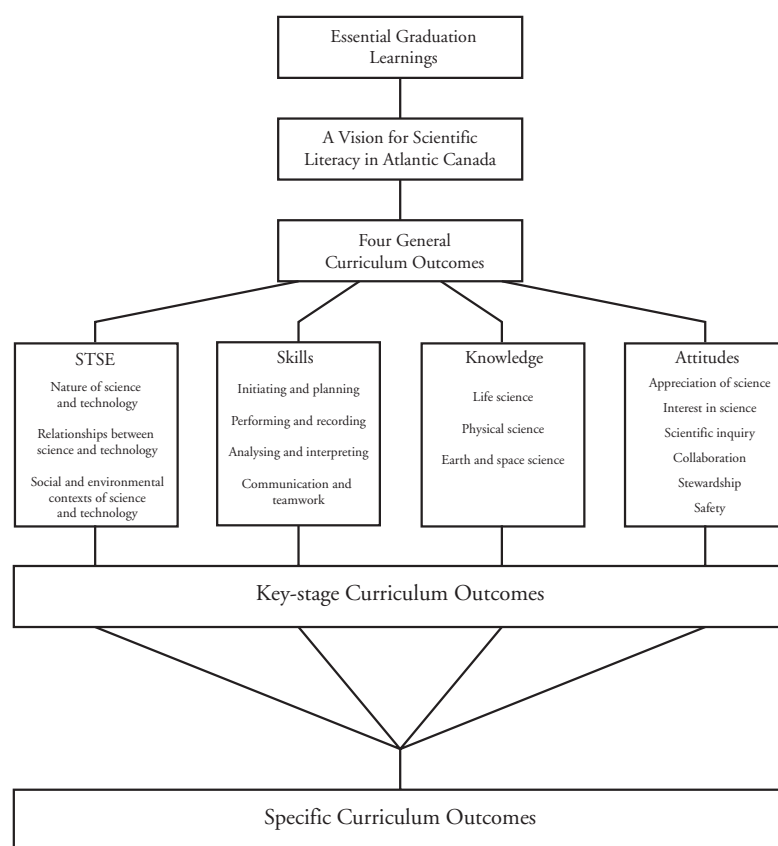

Essential Graduation Learnings

Essential graduation learnings are statements describing the knowledge, skills, and attitudes expected of all students who graduate from high school. Achievement of the essential graduation learnings will prepare students to continue to learn throughout their lives. These learnings describe expectations not in terms of individual school subjects but in terms of knowledge, skills, and attitudes developed throughout the curriculum. They confirm that students need to make connections and develop abilities across subject boundaries and be ready to meet the shifting and ongoing opportunities, responsibilities, and demands of life after graduation. Provinces may add additional essential graduation learnings as appropriate. The essential graduation learnings are described below.

Aesthetic Expression

Graduates will be able to respond with critical awareness to various forms of the arts and be able to express themselves through the arts.

Citizenship

Graduates will be able to assess social, cultural, economic, and environmental interdependence in a local and global context.

Communication

Graduates will be able to use the listening, viewing, speaking, reading, and writing modes of language(s), as well as mathematical and scientific concepts and symbols, to think, learn, and communicate effectively.

Personal Development

Graduates will be able to continue to learn and to pursue an active, healthy lifestyle.

Problem Solving

Graduates will be able to use the strategies and processes needed to solve a wide variety of problems, including those requiring language, mathematical, and scientific concepts.

Technological Competence

Graduates will be able to use a variety of technologies, demonstrate an understanding of technological applications, and apply appropriate technologies for solving problems.

General Curriculum Outcomes

The general curriculum outcomes form the basis of the outcomes framework. They also identify the key components of scientific literacy. Four general curriculum outcomes have been identified to delineate the four critical aspects of students' scientific literacy. They reflect the wholeness and interconnectedness of learning and should be considered interrelated and mutually supportive.

Science, Technology, Society, and the Environment (STSE)

Students will develop an understanding of the nature of science and technology, of the relationships between science and technology, and of the social and environmental contexts of science and technology.

Skills

Students will develop the skills required for scientific and technological inquiry, for solving problems, for communicating scientific ideas and results, for working collaboratively, and for making informed decisions.

Knowledge

Students will construct knowledge and understandings of concepts in life science, physical science, and Earth and space science and will apply these understandings to interpret, integrate, and extend their knowledge.

Attitudes

Students will be encouraged to develop attitudes that support the responsible acquisition and application of scientific and technological knowledge to the mutual benefit of self, society, and the environment.

Key-Stage Curriculum Outcomes

Key-stage curriculum outcomes are statements that identify what students are expected to know, be able to do, and value by the end of grades 3, 6, 9, and 12 as a result of their cumulative learning experiences in science. The key-stage curriculum outcomes are from the pan-Canadian *Common Framework of Science Learning Outcomes K to 12*.

Specific Curriculum Outcomes

This curriculum guide outlines specific curriculum outcomes for Science 6 and provides suggestions for learning, teaching, assessment, and resources to support students' achievement of these outcomes. Teachers should consult *Foundation for the Atlantic Canada Science Curriculum* for descriptions of the essential graduation learnings, vision for scientific literacy, general curriculum outcomes, and key-stage curriculum outcomes.

Specific curriculum outcome statements describe what students are expected to know and be able to do at each grade level. They are intended to help teachers design learning experiences and assessment tasks. Specific curriculum outcomes represent a framework for assisting students to achieve the key-stage curriculum outcomes, the general curriculum outcomes, and, ultimately, the essential graduation learnings.

Specific curriculum outcomes are organized in four units. Each unit is organized by topic. Science 6 units and topics follow.

**Physical Science:
Electricity**

- Uses for Electricity
- Investigating Static Electricity
- Circuit Pathways
- Electromagnets and Electric Generators
- Consumption and Conservation

Physical Science: Flight

- Drag
- Lift and Wing Shape
- Lift
- Thrust and Propulsion

**Earth and Space
Science: Space**

- Space Exploration
- Relative Position and Motion of Earth, the Moon, and the Sun
- The Solar System
- Stars and Constellations

**Life Science: Diversity
of Life**

- The Role of a Common Classification Scheme for Living Things
- The Animal Kingdom: Vertebrates and Invertebrates
- Micro-organisms
- Adaptations and Natural Selection

This page and the following three pages outline specific curriculum outcomes—grouped by units and topics—for Science 6.

Physical Science: Electricity

Students will be expected to

Uses for Electricity

- demonstrate how electricity in circuits can produce light, heat, sound, motion, and magnetic effects (303-26)
- describe how electricity has led to inventions and discuss electrical safety features at work and at play (107-9, 106-4, 108-2, 303-31)

Investigating Static Electricity

- make predictions and investigate static electricity and draw conclusions based on evidence (104-5, 204-3, 204-7, 205-9, 206-5)

Circuit Pathways

- compare a variety of electrical pathways by constructing simple circuits, series circuits, and parallel circuits and illustrate them with appropriate symbols (303-23, 303-25, 207-2)
- perform activities that compare the conductivity of different solids and liquids (205-3, 300-20)
- describe the role of switches in electrical circuits and identify materials that can be used to make a switch (303-24, 204-8)

Electromagnets and Electric Generators

- investigate and describe the relationship between electricity and magnetism using electromagnets and electric generators (204-1, 303-27, 303-22)

Consumption and Conservation

- explain various methods by which electricity is generated, including renewable and non-renewable (105-3, 303-28, 303-29)
- describe how our actions could lead to reducing electrical energy consumption in our environment (108-5, 108-8, 303-30, 106-3)

Physical Science: Flight

Students will be expected to

Drag

- demonstrate methods for altering drag in flying devices and describe and show improvements in design (206-6, 301-18)

Lift and Wing Shape

- identify characteristics and adaptations from living things that have led to flight designs (104-3, 106-3, 300-21)
- plan and perform a fair test demonstrating the characteristics that influence lift on objects in flight (204-7, 301-17, 303-32)

Lift

- identify characteristics and adaptations from living things that have led to flight designs (104-3, 106-3, 300-21)
- identify and collect information using models that involve lift (205-5, 303-33)

Thrust and Propulsion

- describe examples of technological design between aircraft and spacecraft and their influence on our lives (105-3, 107-9, 300-22)
- describe and demonstrate the means of propulsion for flying devices, using a variety of sources (303-34)

**Earth and Space
Science: Space**

Students will be expected to

Space Exploration

- describe and give examples of information and contributions that have led to new inventions and applications (106-3, 107-15, 206-4)
- describe and compare how different societies have interpreted natural phenomena, using a variety of sources, to validate scientific knowledge (105-6, 205-8, 107-3)
- describe, based on evidence, and make conclusions about how astronauts are able to meet their basic needs in space (206-5, 301-21)

Relative Position and Motion of Earth, the Moon, and the Sun

- demonstrate how Earth's rotation causes the day and night cycle and how Earth's revolution causes the yearly cycle of seasons (301-19)
- observe and explain how the relative positions of Earth, the moon, and the sun are responsible for the moon phases, eclipses, and tides (301-20)

The Solar System

- gather information, describe, and display the physical characteristics of components of the solar system (205-2, 300-23, 104-8)

Stars and Constellations

- identify constellations from diagrams, pictures, and/or representations of the night sky (302-13, 207-2)
- describe and compare how different societies have interpreted natural phenomena, using a variety of sources, to validate scientific knowledge (105-6, 205-8, 107-3)

**Life Science:
Diversity of Life**

Students will be expected to

The Role of a Common Classification Scheme for Living Things

- create and analyse their own chart or diagram for classifying and describe the role of a common classification system (206-1, 206-9, 300-15)

The Animal Kingdom: Vertebrates and Invertebrates

- classify animals as vertebrates or invertebrates and compare the characteristics of mammals, birds, reptiles, amphibians, and fishes (300-16, 300-17)
- classify common arthropods using a variety of sources (205-8, 300-18)

Micro-organisms

- identify and use appropriate tools to examine micro-organisms and describe how they meet their basic needs (204-8, 300-19, 302-12)
- provide examples of how science and technology have been used in identifying and controlling micro-organisms by different people around the world (107-3, 107-6)

Adaptations and Natural Selection

- propose questions and gather information about the relationship among the structural features of plants and animals in their environments and identify the positive and negative impacts of humans on these resources (204-1, 108-8)
- classify and compare the adaptations of closely related animals living in their local habitat and in different parts of the world and discuss reasons for any differences (301-15, 104-5, 204-6)
- identify changes in animals over time and research and model the work of scientists (107-11, 207-4, 301-16)

Attitudes Outcomes

It is expected that the Atlantic Canada science program will foster certain attitudes in students throughout their school years. The STSE, skills, and knowledge outcomes that contribute to the development of attitudes, and opportunities for fostering these attitudes are highlighted in the Elaborations—Strategies for Learning and Teaching section of each unit.

Attitudes refer to generalized aspects of behaviour that teachers model for students by example and by selective approval. Attitudes are not acquired in the same way as skills and knowledge. The development of positive attitudes plays an important role in students' growth by interacting with their intellectual development and by creating readiness for responsible application of what students learn.

Since attitudes are not acquired in the same way as skills and knowledge, outcome statements for attitudes are written as key-stage curriculum outcomes for the end of grades 3, 6, 9, and 12. These outcome statements are meant to guide teachers in creating a learning environment that fosters positive attitudes.

The following two pages present the attitudes outcomes from the pan-Canadian *Common Framework of Science Learning Outcomes K to 12* for the end of grade 6.

Key-Stage Curriculum Outcomes: Attitudes

From grade 4 through grade 6, students will be expected to

Appreciation of Science	Interest in Science	Scientific Inquiry
<p>409 appreciate the role and contribution of science and technology in their understanding of the world</p> <p>410 realize that the applications of science and technology can have both intended and unintended effects</p> <p>411 recognize that women and men of any cultural background can contribute equally to science</p> <p><i>Evident when students, for example,</i></p> <ul style="list-style-type: none"> • recognize that scientific ideas help explain how and why things happen • recognize that science cannot answer all questions • use science inquiry and problem-solving strategies when given a question to answer or a problem to solve • plan their actions to take into account or limit possible negative and unintended effects • are sensitive to the impact their behaviour has on others and the environment when taking part in activities • show respect for people working in science, regardless of their gender, their physical and cultural characteristics, or their views of the world • encourage their peers to pursue science-related activities and interests 	<p>412 show interest and curiosity about objects and events within different environments</p> <p>413 willingly observe, question, explore, and investigate</p> <p>414 show interest in the activities of individuals working in scientific and technological fields</p> <p><i>Evident when students, for example,</i></p> <ul style="list-style-type: none"> • attempt to answer their own questions through trial and careful observation • express enjoyment in sharing and discussing with classmates science-related information gathered from books, magazines, newspapers, videos, digital discs, the Internet, or personal discussions with family members, teachers, classmates, and experts • ask questions about what scientists in specific fields do • express enjoyment from reading science books and magazines • willingly express their personal way of viewing the world • demonstrate confidence in their ability to do science • pursue a science-related hobby • involve themselves as amateur scientists in exploration and scientific inquiry, arriving at their own conclusions rather than those of others • ask to use additional science equipment to observe objects in more detail • express the desire to find answers by exploring and conducting simple experiments 	<p>415 consider their own observations and ideas as well as those of others during investigations and before drawing conclusions</p> <p>416 appreciate the importance of accuracy and honesty</p> <p>417 demonstrate perseverance and a desire to understand</p> <p><i>Evident when students, for example,</i></p> <ul style="list-style-type: none"> • ask questions to ensure they understand • respond positively to the questions posed by other students • listen attentively to the ideas of other students and consider trying out suggestions other than their own • listen to, recognize, and consider differing opinions • open-mindedly consider non-traditional approaches to science • seek additional information before making a decision • base conclusions on evidence rather than preconceived ideas or hunches • report and record what is observed, not what they think ought to be or what they believe the teacher expects • willingly consider changing actions and opinions when presented with new information or evidence • record accurately what has been seen or measured when collecting evidence • take the time to repeat a measurement or observation for greater precision • ask questions about what would happen in an experiment if one variable were changed • complete tasks undertaken or all steps of an investigation • express the desire to find answers by conducting simple experiments

Key-Stage Curriculum Outcomes: Attitudes

From grade 4 through grade 6, students will be expected to

Collaboration	Stewardship	Safety
<p>418 work collaboratively while exploring and investigating</p> <p><i>Evident when students, for example,</i></p> <ul style="list-style-type: none"> • complete group activities or projects • willingly participate in co-operative problem solving • stay with members of the group during the entire work period • willingly contribute to the group activity or project • willingly work with others, regardless of their age, their gender, or their physical or cultural characteristics • willingly consider other people's views of the world 	<p>419 be sensitive to and develop a sense of responsibility for the welfare of other people, other living things, and the environment</p> <p><i>Evident when students, for example,</i></p> <ul style="list-style-type: none"> • choose to have a positive effect on other people and the world around them • frequently and thoughtfully review the effects and consequences of their actions • demonstrate a willingness to change their behaviour to protect the environment • respect alternative views of the world • consider cause-and-effect relationships that exist in environmental issues • recognize that responding to our wants and needs may negatively affect the environment • choose to contribute to the sustainability of their community through individual positive actions • look beyond the immediate effects of an activity and identify its effects on others and the environment • willingly suggest how we can protect the environment 	<p>420 show concern for their safety and that of others in planning and carrying out activities and in choosing and using materials</p> <p>421 become aware of potential dangers</p> <p><i>Evident when students, for example,</i></p> <ul style="list-style-type: none"> • look for labels on materials and seek help to interpret them • ensure that all steps of a procedure or all instructions given are followed • repeatedly use safe techniques when transporting materials • seek counsel of the teacher before disposing of any materials • willingly wear proper safety attire, when necessary • recognize their responsibility for problems caused by inadequate attention to safety procedures • stay at their own work area during an activity, to minimize distractions and accidents • immediately advise the teacher of spills, breaks, or unusual occurrences • share in cleaning duties after an activity • seek assistance immediately for any first-aid concerns like cuts, burns, and unusual reactions • keep the work station uncluttered, with only appropriate materials present

Curriculum Guide Organization

Specific curriculum outcomes are organized into units for each grade level. Each unit is organized by topic. Suggestions for learning, teaching, assessment, and resources are provided to support student achievement of the outcomes.

The order in which the units of a grade appear in the guide is meant to suggest a sequence. In some cases, the rationale for the recommended sequence is related to the conceptual flow across the year. That is, one unit may introduce a concept that is then extended in a subsequent unit. Likewise, one unit may focus on a skill or context that will be built upon later in the year.

Some units or certain aspects of units may also be combined or integrated. This is one way of assisting students as they attempt to make connections across topics in science or between science and the real world. In some cases, a unit may require an extended time frame to collect data on weather patterns, plant growth, etc. These cases may warrant starting the activity early and overlapping it with the existing unit. In all cases, the intent is to provide opportunities for students to deal with science concepts and scientific issues in personally meaningful and socially and culturally relevant contexts.

Unit Organization

Each unit begins with a two-page synopsis. On the first page, an introductory paragraph provides a unit overview. This is followed by a section that specifies the focus (inquiry, problem solving, and/or decision making) and possible contexts for the unit. Finally, a curriculum-links section specifies how this unit relates to science concepts and skills addressed in other grades (so teachers will understand how the unit fits with the students' progress through the complete science program).

The second page of the two-page overview provides a table of the outcomes from *Common Framework of Science Learning Outcomes K to 12* that the unit will address. The numbering system used is the one in the pan-Canadian document, as follows:

- 100s—STSE outcomes
- 200s—Skills outcomes
- 300s—Knowledge outcomes
- 400s—Attitudes outcomes (See pages 16–18.)

These code numbers appear in parentheses after each specific curriculum outcome.

The Four-Column Spread

Outcomes in each unit are grouped by a topic indicated at the top of the left-hand page. All topics have a two-page spread of four columns as illustrated below. In some cases, the four-column spread continues to the next two-page spread.

Two-Page, Four-Column Spread

LIFE SCIENCE: DIVERSITY OF LIFE		LIFE SCIENCE: DIVERSITY OF LIFE	
Adaptations and Natural Selection		Adaptations and Natural Selection	
<p>Outcomes</p> <p><i>Students will be expected to</i></p> <ul style="list-style-type: none"> propose questions and gather information about the relationship among the structural features of plants and animals in their environments and identify the positive and negative impacts of humans on these resources (204-1, 108-8) classify and compare the adaptations of closely related animals living in their local habitat and in different parts of the world and discuss reasons for any differences (301-15, 194-5, 204-6) identify changes in animals over time and research and model the work of scientists (107-11, 207-4, 301-16) 	<p>Elaborations—Strategies for Learning and Teaching</p> <p>During classroom discussion, encourage students to ask questions about the adaptations and structural features of organisms. For example, students might ask, “Why does this frog have such a long tongue?” Questions like these should be rephrased to “What does the frog use his long tongue for?” and used as the basis of further investigation. Students can study the organisms they found in their field study to see the features that they have that help them live in their particular habitat. Students should explore similar organisms that live in different parts of the world (e.g., arctic hare and snowshoe hare) and inquire about the structural differences in these organisms and how these structural differences help them to survive and grow in their environment. Students can inquire into the conditions that have led to the endangerment of various species. Students can investigate local and global examples to see how information about population size is determined. Students can gather information about natural attraction of species. This will encourage students to be aware of and develop a respect and understanding for the welfare of living things. Students should explore what types of fossils have been found and the theories that exist about what caused particular organisms (e.g., dinosaurs) to become extinct. Field trips to fossil exhibits or local sites, the use of software, the Internet, print resources, and audiovisual resources would also be good sources of information about fossils. Students should also investigate the tools and techniques paleontologists use to acquire knowledge about fossils. The focus is on how paleontologists do their work (finding and cleaning fossils, trying to piece together skeletal remains, trying to estimate the age of the fossils) and contrast with some of the techniques and tools available (computer-generated drawings of dinosaurs, carbon dating so that a more accurate age of the fossil can be determined). The goal is for students to see that improvements in scientific techniques and technological tools can lead to better scientific knowledge. The goal is not to be able to explain how these new techniques and technological tools actually work. This section provides an excellent opportunity for students to explore a variety of science-related careers related to the diversity of life. Connections can be made to the study of fossils through exploration of Rocks and Minerals in Science 4 and Ancient Societies in Science 5.</p>	<p>Tasks for Instruction and/or Assessment</p> <p><i>Performance</i></p> <ul style="list-style-type: none"> Carefully examine fossils. Draw the fossil and write a story about its journey. (107-11, 207-4, 301-16) <p><i>Journal</i></p> <ul style="list-style-type: none"> Write about your personal feelings regarding endangerment of local species. (204-1, 108-8) <p><i>Paper and Pencil</i></p> <ul style="list-style-type: none"> Choose a pair of animals below and find out in what part of the world they are usually found. Describe one difference between each of them and describe how that difference helps that animal survive in its habitat. Examples that might be used include brown bear and polar bear, red fox and arctic fox, red-eyed tree walker frog and poison dart frog, or beluga whale and orca whale. (301-15, 194-5, 204-6) Write a report about paleontologists. Include a description of what they study, some of the techniques they use in their work, and how their work has contributed to our understanding of life on Earth in the past. (107-11, 207-4, 301-16) <p><i>Presentations</i></p> <ul style="list-style-type: none"> Choose an organism and describe the structural features that enable it to survive in its environment. Focus on the structural features that the organism has for moving, obtaining food, and protecting itself. Describe how these help it to survive in its environment. Present your findings to the class using drawings, pictures, videos, or skits. (204-1, 108-8) From a list of endangered species, choose one and research it. What factors have caused its endangerment? What is being done to protect it? Work in pairs and present your findings to the class. (204-1, 108-8) Create a poster showing extinct organisms that lived on Earth long ago and similar organisms that live on Earth today. (107-11, 207-4, 301-16) 	<p>Resources/Notes</p> <p><i>Activities from Appendix 11</i></p> <ul style="list-style-type: none"> Activity 43: Trees All around Us Activity 44: Plants in My Habitat Activity 45: Animals in My Habitat Activity 54: Structural Features of Organisms Activity 55: Endangered Species Activity 56: Paleontologists <p><i>Print</i></p> <ul style="list-style-type: none"> Sci-Zed Connections 6, Section D, pp. 32–40, 56-61 (17027) Nova Scotia Science 6, pp. 234–247, 250–253 (18499) <p><i>Curriculum Links</i></p> <ul style="list-style-type: none"> Health Education: SCO C4.1 Social Studies: SCOs 6.2.3 and 6.5.3
72	ATLANTIC CANADA SCIENCE CURRICULUM: GRADE 6	ATLANTIC CANADA SCIENCE CURRICULUM: GRADE 6	73

Column One: Outcomes

The first column provides the specific curriculum outcomes. These are based on the pan-Canadian *Common Framework of Science Learning Outcomes K to 12*. The statements involve STSE, skills, and knowledge outcomes indicated by the outcome number(s) that appear(s) in parentheses after the outcome. Some STSE and skills outcomes have been written in a context that shows how these outcomes should be addressed.

Specific curriculum outcomes have been grouped by topic. Other groupings of outcomes are possible and in some cases may be necessary to take advantage of local situations. The grouping of outcomes provides a suggested teaching sequence. Teachers may prefer to plan their own teaching sequences to meet the learning needs of their students.

In grade 6, the STSE and knowledge outcomes are combined.

Columns one and two define what students are expected to learn and be able to do.

*Column Two: Elaborations—
Strategies for Learning and
Teaching*

The second column may include elaborations of outcomes listed in column one and describes learning environments and experiences that will support students' learning.

The strategies in this column are intended to provide a holistic approach to instruction. In some cases, they address a single outcome; in other cases, they address a group of outcomes.

*Column Three:
Tasks for Instruction
and/or Assessment*

The third column provides suggestions for ways in which students' achievement of the outcomes could be assessed. These suggestions reflect a variety of assessment techniques and materials that include, but are not limited to, informal/formal observation, performance, journal, interview, paper and pencil, and presentation. Some assessment tasks may be used to assess student learning in relation to a single outcome, others to assess student learning in relation to several outcomes. The assessment item identifies the outcome(s) addressed by the outcome number(s) in parentheses after the item.

*Column Four:
Resources/Notes*

This column includes activities to support student achievement in meeting specific curriculum outcomes. These activities are found in Appendix E–H of this guide; print resources available through the Nova Scotia School Book Bureau (order numbers are listed beside the titles); videos available through the Education Media Library and the Learning Resources and Technology website (call numbers are listed beside titles); and in links to other curriculum areas, where applicable. This column also provides an opportunity for teachers to make notes about other useful resources.

Specific Curriculum Outcomes

Physical Science: Electricity

Introduction

Students encounter electricity every day of their lives. A basic understanding of how electricity works can help students recognize the need for safe practices when around electricity, begin to realize that they have control over how much electricity they use in the home and at school, and begin to understand the impact energy consumption has on resources used to generate electricity.

Focus and Context

There is a dual focus in this unit—inquiry and problem solving. Students should be encouraged to investigate which materials conduct electricity and compare a variety of circuit pathways. From this, they should be able to design solutions to electrical problems by completing various circuit pathways.

The context for this topic should be on electrical systems. Our society's reliance on electricity is pervasive; one need only think about the implications of an extended blackout to realize the extent to which our society depends on electricity. Electrical appliances, houses, small towns, and large cities use and depend on electricity to function.

Science Curriculum Links

This unit follows from Science 3, Invisible Forces, in which students explore static electricity. Students will explore electricity in further depth in Science 9.

Curriculum Outcomes

The following outcomes have been developed from the pan-Canadian outcomes in *Common Framework of Science Learning Outcomes K to 12*. See Appendix J for the original outcomes from which these were derived.

STSE	Skills	Knowledge
<p><i>Students will be expected to</i> 107-9, 106-4, 108-2, 303-31 describe how electricity has led to inventions and discuss electrical safety features at work and at play 108-5, 108-8, 303-30, 106-3 describe how our actions could lead to reducing electrical energy consumption in our environment 105-3, 303-28, 303-29 explain various methods by which electricity is generated, including renewable and non-renewable</p>	<p><i>Students will be expected to</i> 204-1, 303-27, 303-22 investigate and describe the relationship between electricity and magnetism using electromagnets and electric generators 104-5, 204-3, 204-7, 205-9, 206-5 make predictions and investigate static electricity and draw conclusions based on evidence 205-3, 300-20 perform activities that compare the conductivity of different solids and liquids</p>	<p><i>Students will be expected to</i> 303-26 demonstrate how electricity in circuits can produce light, heat, sound, motion, and magnetic effects 303-23, 303-25, 207-2 compare a variety of electrical pathways by constructing simple circuits, series circuits, and parallel circuits and illustrate them with appropriate symbols 303-24, 204-8 describe the role of switches in electrical circuits and identify materials that can be used to make a switch</p>

Uses for Electricity

Outcomes

Students will be expected to

- demonstrate how electricity in circuits can produce light, heat, sound, motion, and magnetic effects (303-26)
- describe how electricity has led to inventions and discuss electrical safety features at work and at play (107-9, 106-4, 108-2, 303-31)

Elaborations—Strategies for Learning and Teaching

Students should use tools and apparatus such as batteries, bulbs, and wires for the various activities throughout this unit. Since students will be working with various electrical devices, safety outcomes should be reinforced throughout the unit.

Students should be made aware of the dangers of shock related to electrical sockets, especially when it comes to inserting metallic objects in them. This addresses outcomes related to insulators and conductors.

Electrical safety can be addressed through project work, safety videos, classroom discussions, or class presentations by electricians or the fire department. Qualified people should be used. Students should be made aware of electrical dangers such as taking electrical devices like radios into the bathroom or near the bath; fallen power lines; climbing transmission towers, climbing trees, or flying kites near power lines; frayed or exposed wires; pulling out plugs by the cord; and taking apart electrical appliances (some contain capacitors that store electrical charge even if unplugged).

Describe how the light bulb is used today compared with the bulbs that have a shorter lifespan.

Energy comes in many forms, such as light, heat, sound, and motion. All kinds of buzzers, lights, solar cells, motors, and electromagnets can be used. Heat can be demonstrated by feeling the light bulb warm up or by displaying electrical devices that convert electrical energy into heat (toasters, curling irons, kettles).

⚠ Caution: Check the voltage rating on the device. Some of them need a power supply with greater than three volts.

These devices should have a minimum voltage requirement of 1–3 volts, so they can be run on a battery-powered circuit or else you will be using too many batteries to get it to work. Students can make circuits using these devices to see how they work.

Uses for Electricity

Tasks for Instruction and/or Assessment

Performance

- Use the design process to solve a problem such as turning a light on or off from either end of a corridor or creating an alarm for a toy box. (303-26)

Journal

- Pretend you live in the days before electricity. In your journal, write about your activities. Be sure to refer to activities for which we would use electricity today. (107-9, 106-4, 108-2, 303-31)

Presentation

- Create a poster or web page, including illustrations, labels, and captions, to identify electrical dangers at work and play and to identify electrical safety devices/procedures that protect us from these dangers. (107-9, 106-4, 108-2, 303-31)
- Make a public service advertisement that provides safety information about electricity. (107-9, 106-4, 108-2, 303-31)

Resources/Notes

Activities from Appendix E

- Activity 1: Electrical Dangers
- Activity 2: Understanding Electrical Dangers
- Activity 12: Investigating Electrical Circuitry
- Activity 13: Solving an Electrical Problem
- Activity 14: Electricity and Inventions

Print

- *Understanding Electricity*, National Geographic Reading Expeditions, Physical Science (13499)
- *Nova Scotia Science 6*, p. 12 (18499)

Curriculum Link

- English Language Arts: GCO 8
- Health Education: SCO B3.3

Uses for Electricity (cont'd)

Outcomes

Students will be expected to

- demonstrate how electricity in circuits can produce light, heat, sound, motion, and magnetic effects (303-26)
- describe how electricity has led to inventions and discuss electrical safety features at work and at play (107-9, 106-4, 108-2, 303-31)

Elaborations—Strategies for Learning and Teaching

Students should design a circuit. Challenge students to think of an electrical task. For example, they could design a circuit that will not shut off if one light bulb is removed or one that will; a circuit with switches that activate the circuit on contact or one with switches that turn off the circuit on contact; circuits that have two places to turn a circuit off or on; or circuits with buzzers that are activated by touching something. Give them a wide variety of electrical apparatus (such as wires, buzzers, light bulbs) to try to design solutions.

Students should identify and describe the uses of electricity in everyday life. One activity that can get students thinking about the many electrical inventions they use and how they depend on electricity is to describe their experiences when the power goes out. How do they cope without electricity?

Students could interview parents, grandparents, and/or older people in the community about electrical devices that have been developed in their lifetimes and how these devices have changed their lives.

Students can read articles and/or identify preventive or safety features that have developed, such as the three-prong plug, circuit breakers, grounding wires, and fuses. Guest speakers, such as utility company personnel, could be invited to the class.

Students can create charts, collages, videos, or other displays that illustrate electrical safety.

Uses for Electricity *(cont'd)*

Tasks for Instruction and/or Assessment

Paper and Pencil

- Identify new inventions and electrical features that are used today. (107-9, 106-4, 108-2, 303-31)
- Put checks in the chart to indicate the attributes that the electrical device might create. (303-26)

Property Chart of Electrical Devices

Device	Heat	Motion	Sound	Magnetic	Light
buzzer					
speaker					

Resources/Notes

Print

- *Nova Scotia Science 6*, Rule #7, p. ix (18499)

Investigating Static Electricity

Outcome

Students will be expected to

- make predictions and investigate static electricity and draw conclusions based on evidence (104-5, 204-3, 204-7, 205-9, 206-5)

Elaborations—Strategies for Learning and Teaching

You should model and students should use proper scientific terminology such as **attraction**, **repulsion**, **positive charge**, and **negative charge**.

Students will have already investigated static electricity in Science 3, Invisible Forces. Brainstorm with students about their previous experiences and do activities with static electricity by exploring with a variety of materials like balloons, fur, fabrics, rubber rods, Styrofoam balls, bits of paper or confetti, and plastic combs. Students should explore the following questions: Which combination of materials, when rubbed, will pick up the most pieces of confetti or puffed rice? Which combination of materials, when rubbed, will attract a hanging piece of yarn the most? Can they get two identical objects to attract? Can they get two identical objects to repel? Can they get two different objects to attract? Can they get two different objects to repel? Students should record their procedures, observations, and measurements. Students should decide the question(s) to explore and should write the procedure(s). Assessment of the procedure(s) is appropriate as well as a data table after a particular test is completed. You will need to decide what you are evaluating for an experiment, as there may be several skills that the students need practice in developing.

In tasks that involve trying to attract the most puffed rice, students can compare their results with those of other students and attempt to explain any differences. They can decide if all the variables were controlled in the same manner or if they were uncontrolled. This is important in order to determine a fair test. Even if two groups have seemingly identical conditions, there may be differences in their results due to experimental error (e.g., human error, slight differences in yarn or confetti, slight differences in rubbing). Students should compare results and see that identical results are not always achieved. Static electricity is very difficult to control, and students should not expect to get the same result every time.

Explore students' explanations of which objects may attract while other times they repel. What causes attraction and repulsion? You can write and display these explanations for the class to examine. This guided discussion should lead to the development of the concepts of positive charge and negative charge and how these two types of charges interact in terms of attraction and repulsion. The concept of electric charges can be concretely developed by students getting a shock when they walk over carpet. The concept of static electricity, or charge that is stationary on one object, should also be developed.

Investigating Static Electricity

Tasks for Instruction and/or Assessment

Performance

- Select from the materials provided and solve the static electricity challenge. Record each strategy that you tried in solving the challenge and your observations. Identify the strategy that gave you the best results. (104-5, 204-3, 204-7, 205-9, 206-5)

Journal

- Static electricity can be very tricky! Encourage students to write about their results. Did they get the same results when they repeated a set of steps? For example, they can rub a balloon three times, then see how many pieces of confetti they pick up. They can compare their results with those of other groups. They should recognize that sometimes results will vary. (104-5, 204-3, 204-7, 205-9, 206-5)

Paper and Pencil

- Create a crossword puzzle using terms related to static electricity. Trade with other students and do their puzzle. (104-5, 204-3, 204-7, 205-9, 206-5)
- Create a procedure for your experiment on static electricity. (104-5, 204-3, 204-7, 205-9, 206-5)
- Fill in a data table with your experiment results. (104-5, 204-3, 204-7, 205-9, 206-5)

Resources/Notes

Activities from Appendix E

- Activity 3: Exploring Static Electricity
- Activity 4: Analysing Static Electricity
- Activity 5: Static Electricity—Attraction and Repulsion

Print

- *Sci-Tech Connections 6*, Section C, p. 83 (17027)
- *Nova Scotia Science 6*, pp. 6–11 (18499)

Video

- *Electrical Current: Light Optics* (50 min.) (23116)

Circuit Pathways

Outcomes

Students will be expected to

- compare a variety of electrical pathways by constructing simple circuits, series circuits, and parallel circuits and illustrate them with appropriate symbols (303-23, 303-25, 207-2)
- perform activities that compare the conductivity of different solids and liquids (205-3, 300-20)
- describe the role of switches in electrical circuits and identify materials that can be used to make a switch (303-24, 204-8)

Elaborations—Strategies for Learning and Teaching

After revisiting static/stationary electricity, students then move on to an exploration of current or moving electricity. Students can use batteries, wires, and light bulbs to try to make a variety of circuit pathways and find out which pathways allow electricity to flow. Model for students the proper way to draw their circuit diagrams, using appropriate symbols for cells, batteries, light bulbs, switches, and other devices they may add later in the unit. Students should make drawings to show which pathways allowed electricity to flow and which ones did not.

Insulators and **conductors** are important words in electricity. Students can make a conductivity tester using batteries, wires, a low-voltage light bulb, or compass to detect when a current is flowing. Groups of students can work with materials such as lengths of copper wire, light bulbs, tape, and a variety of materials to test for conductivity, such as paper clips, plastic spoons and beakers of water, salt water, or sugar water. They can then group materials as either conductors or insulators. The results can be recorded in chart form.

Draw a variety of diagrams of circuits, some of which do not have a switch and some of which are not complete circuits. Students should be able to decide which circuits would conduct electricity. Probe their understanding of circuits without switches. Students should be able to relate their findings about conductors and insulators to the types of materials that would make a good switch.

Students can explore various circuit pathways, in particular, series and parallel circuits. Using batteries, wire, light bulbs, and connectors (either tape or electrical connectors), students can construct both types of circuits and investigate the properties of each by breaking the circuit at various points (the bulb will go off in a series circuit) or the relative brightness of lights.

Students can take apart and examine a variety of simple electrical devices, like a flashlight or a plug and wire, to try to explain how the circuit is completed. Circuit testers and simple voltmeters can be used to accurately measure changes in electrical characteristics.

Probe students' conceptions of electricity by asking questions like, How is the static electricity on our clothes or in our hair different from the electricity that runs this clock (or some other appliance)? Can I use static electricity to light the bulb in a series circuit? Lead the discussion so that students understand that current electricity is a charge (electrons) that can move along a closed path, while in static electricity, the charge is localized on an object. Is the battery dead? Are the connections tight? Is there a break in the wire? How can they test these possibilities?

Circuit Pathways

Tasks for Instruction and/or Assessment

Performance

- Determine which of the materials (e.g., paper clips, erasers, aluminium foil, salt water, cotton) are insulators or conductors. Create a wall chart of conductors/insulators from students' collected results. From the diagram of the simple circuit, construct a working model with the materials provided. (303-23, 303-25, 207-2)

Interview

- What is the difference between insulators and conductors? Give examples of each. (205-3, 300-20)

Paper and Pencil

- What light bulbs (A, B, or both) will be on if
 - switch 1 is open and switch 2 is closed.
 - switch 1 is closed and switch 2 is open. (303-24, 204-8)

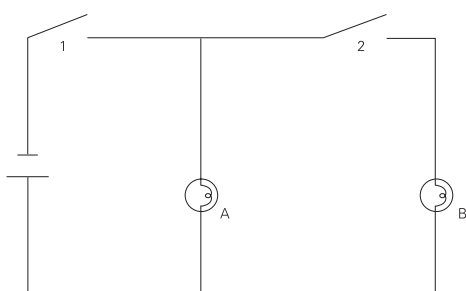

- If a second bulb is added to a series circuit, what happens? Include the diagram with your explanation. (303-23, 303-25, 207-2)

Resources/Notes

Activities from Appendix E

- Activity 6: Simple Circuits
- Activity 7: Insulators and Conductors
- Activity 8: Series and Parallel Circuits
- Activity 9: Switches

Print

- Sci-Tech Connections 6*, Section C, pp. 86–88 (17027)
- Nova Scotia Science 6*, pp. 18, 22–27, 28–33

Video

- Creating and Controlling Current Electricity* (13 min.) (22912)

Electromagnets and Electric Generators

Outcome

Students will be expected to

- investigate and describe the relationship between electricity and magnetism using electromagnets and electric generators (204-1, 303-27, 303-22)

Elaborations—Strategies for Learning and Teaching

Provide students with the materials to make an electromagnet. Electromagnets use a battery, a length of insulated wire, and a long iron nail or spike to wrap the wire around and a compass or paper clips, staples, or other small magnetic objects to detect the magnetism.

Once students make an electromagnet, they can experiment with ways to increase its strength. They can then state their thoughts in the form of a testable question and compose a hypothesis and predictions. Some factors that they might like to try are the voltage of the batteries (see caution below), the number of wraps of wire around the nail, the type of nail, the size of the nail, and the type of wire. They can test their electromagnet by seeing how much a compass needle deflects or by counting the number of staples or paper clips the electromagnet attracts. In groups, they can plan their strategies, brainstorming possibilities, making predictions, and testing their hypotheses.

Many devices that use electromagnets (telephones, televisions, radios, and microphones) can be displayed in the classroom. Pictures of heavy objects that are being lifted using electromagnets can be used to illustrate the power that they have. Students can investigate simple devices like doorbells to see how the electromagnets cause the bell to work.

Students should explain that the production of electricity by passing a magnet by wire has led to the invention of electrical generators. Students have already investigated how electricity can generate magnetism (electromagnets). A good way to lead into this section is to investigate the reverse of this (generating electricity from magnets). Students will need a fairly sensitive way to detect electricity (galvanometer, compass). Using a wire coiled around a tube and connected to a galvanometer, students can move a magnet in various directions around the coil and watch the way the needle on the galvanometer deflects. If they insert the bar magnet in and out of the tube, they should also detect a current in the wire. Alternatively, generators can be purchased from science supplies catalogues. Students could look carefully at these to see the components (coils of wire, rotating magnet) of the generator. By turning the crank at sufficient speeds, students can get light bulbs and buzzers to work.

Electromagnets and Electric Generators

Tasks for Instruction and/or Assessment

Performance

- Carry out procedures to test a variable that could affect the strength of an electromagnet. The plan should include clear statements of the question being explored, hypothesis, materials, procedure, controlled variables, manipulated variables, responding variables, observations, and results. (204-1, 303-27, 303-22)
- Generate your own electricity from chemical energy by making some simple electrochemical cells using copper and zinc strips or nails that are embedded in fruit. Another example is to make a more traditional electrochemical cell by putting the copper nail in a copper solution (copper (II) sulphate or some other copper salt) and the zinc nail or strip in a solution of zinc (II). Connect the two nails by a wire that is hooked up to something that shows that electricity is flowing (bulb or multimeter) and connect the two beakers by soaking a paper towel in a salt (NaCl) solution. Kits such as potato/fruit clocks may be purchased. Students can connect solar cells in circuits to see solar energy being converted into electrical energy. Solar energy kits are available from scientific suppliers. Having different experiments going on at the same time will allow students to view various electrical and energy connections. (204-1, 303-27, 302-22)

Journal

- What did you learn about electromagnets? What else would you like to know? (204-1, 303-27, 303-22)

Interview

- What is an electromagnet? What do you need to make an electromagnet? What makes an electromagnet stronger? (204-1, 303-27, 303-22)
- What invention came from the discovery that magnets can produce an electric current? How is this invention useful to us? (204-1, 303-27, 303-22)

Paper and Pencil

- Compare and contrast electromagnets and generators in terms of what they are made from, their source of energy, and what they do. Decide on a graphic organizer to record your observations. (204-1, 303-27, 303-22)

Presentation

- Collect or draw pictures of devices that use electromagnets. For each, state the role of the electromagnet in the device. (204-1, 303-27, 303-22)

Resources/Notes

Activities from Appendix E

- Activity 10: Making Electromagnets
- Activity 11: Uses of Electromagnets
- Activity 15: Generators

Print

- *Sci-Tech Connections 6*, Section C, p. 89 (17027)
- *Nova Scotia Science 6*, pp. 36–39, 40–43

⚠ Caution: Do not test electromagnets or magnets near computers, computer diskettes, or CD-ROMs.

⚠ Caution: Students should not use battery sources of any more than three volts.

⚠ Caution: Warn students not to try house current coming from the wall in their home or a car battery.

The electromagnets students make have circuits with very little resistance, only very conductive wires. The current that flows in the electromagnets will be relatively large compared to the other circuits they have constructed, and the wires will get hot quite quickly. If they wish to test the effect of increased voltage, get them to use one 1.5 V battery, then repeat with two 1.5 V batteries connected in series.

Consumption and Conservation

Outcomes

Students will be expected to

- explain various methods by which electricity is generated, including renewable and non-renewable (105-3, 303-28, 303-29)
- describe how our actions could lead to reducing electrical energy consumption in our environment (108-5, 108-8, 303-30, 106-3)

Elaborations—Strategies for Learning and Teaching

Brainstorm with students and record their ideas on how electricity is produced. Students should identify chemical (batteries), mechanical (wind, falling water, steam), and solar energy as forms of energy that can be converted into electrical energy. Energy can be converted from chemical, mechanical, solar, and nuclear to electrical energy. Some forms of chemical energy would be batteries and fossil fuel combustion. Sources of energy would be wind, water, tidal, solar, and nuclear.

Renewable forms of energy would be wind, solar, water, and tidal. Non-renewable forms of energy are fossil fuels and nuclear energy.

Students should see the effects of their efforts to conserve energy by collecting data about the consumption before and after they try to reduce electrical usage.

Students could keep an electrical use journal, noting the various electrical devices/systems they encounter over the course of a period of time.

Students can be introduced to some of the units that are used to quantify electrical energy, such as watt and kilowatt-hour. (The depth of treatment should be quite minimal. It is enough that they understand that the watt is a unit of measuring how much electrical energy a device uses and that a kilowatt-hour is the amount of energy being consumed if the device is used for one hour. The more watts or kilowatt-hours a device is rated for, the more electrical energy is being used.) A guest speaker from a power company might be invited to speak to the class about electrical power usage, conservation of electricity, peak power usage times, and how to read an electrical meter.

Students could turn on electrical devices and watch how fast the meter runs. They could turn off the devices to see how this affects the meter. Students could categorize devices according to whether they are high-, medium-, or low-consumption devices (some discussion of kilowatt-hours will be needed). Students could carry out a household inventory of electrical appliances and light bulbs, noting the wattage of bulbs and describing use patterns.

Students could propose ways that consumption can be decreased. Students should discuss the advantages to the environment of using less energy. Students could investigate how the damming of a river affects a local environment or how fossil fuel energy sources contribute to greenhouse gases.

In language arts, students could do a research project, using print and electronic sources, on the various ways of generating electricity and their effect on the environment. This will encourage students to be sensitive to and develop a sense of responsibility for the welfare of the environment.

Consumption and Conservation

Tasks for Instruction and/or Assessment

Journal

- How can you conserve electricity and what effect will this have on the home and family budget? (108-5, 108-8, 303-30, 106-3)
- Reflect on how wasting energy may affect the environment. (108-5, 108-8, 303-30, 106-3)

Paper and Pencil

- Develop strategies to conserve energy in your school. Present your report to the administration. (108-5, 108-8, 303-30, 106-3)

Presentation

- Create a skit/video on how energy conservation benefits the environment. (108-5, 108-8, 303-30, 106-3)
- Create a pictorial concept map showing energy conversions. Choose either chemical, mechanical, or solar energy, and research how electrical energy is produced from the source, whether the source is renewable or non-renewable, and the positive and negative impacts on the environment of using this source to create electricity. Report your findings (web page, report, oral presentation with visual aids). (105-3, 303-28, 303-29)
- Create a video or skit on the impacts on the environment of using a source of energy (renewable or non-renewable) to create electricity. (105-3, 303-28, 303-29)

Resources/Notes

Activity from Appendix E

- Activity 16: Sources of Energy
- Activity 17: Using Electrical Energy Wisely

Print

- *Nova Scotia Science 6*, pp. 44–53

Physical Science: Flight

Introduction

The capability of flight is shared by a variety of living things and human inventions. For many centuries, humans have marvelled at the ability of living things to attain flight, and they have developed a variety of devices to recreate that ability. Students learn to appreciate the science and technology involved as they investigate how things fly and develop and test a variety of prototype devices. Through their investigations, they learn that many different approaches are used and that each provides a means to achieve varying amounts of lift, movement, and control.

Focus and Context

The emphasis in this unit is on how things fly or stay afloat in air and the variables that affect flight. The focus of this unit is, for the most part, problem solving. Students should be immersed in rich experiences with many aspects of air/aerodynamics and flight. Learning experiences related to solving problems (such as, How can I get the airplane to stay in the air longer?) require that the students design, test, and then modify their designs and retest their models. Students should use their imagination, creativity, and research skills in designing model planes and various wing shapes and in devising methods to test their designs. After much classroom experimentation, design, and testing, teams of students should have the opportunity to investigate an aspect of flight that interests them most and present their findings.

By being given opportunities to re-examine and retest, research and rebuild, and share, students will grow in the four broad areas of skills: initiating and planning, performing and recording, analysing and interpreting, and communications and teamwork.

Science Curriculum Links

Students were introduced to the concept of air taking up space and being able to be felt as wind in Science 2, Air and Water in the Environment.

Students will use many of the concepts in this unit in Science 8, Fluids, and in high school physics.

Curriculum Outcomes

The following outcomes have been developed from the pan-Canadian outcomes in *Common Framework of Science Learning Outcomes K to 12*. See Appendix J for the original outcomes from which these were derived.

STSE	Skills	Knowledge
<p><i>Students will be expected to</i></p> <p>104-3, 106-3, 300-21 identify characteristics and adaptations from living things that have led to flight designs</p> <p>105-3, 107-9, 300-22 describe examples of technological design between aircraft and spacecraft and their influence on our lives</p>	<p><i>Students will be expected to</i></p> <p>204-7, 301-17, 303-32 plan and perform a fair test demonstrating the characteristics that influence lift on objects in flight</p> <p>206-6, 301-18 demonstrate methods for altering drag in flying devices and describe and show improvements in design</p> <p>205-5, 303-33 identify and collect information using models that involve lift</p>	<p><i>Students will be expected to</i></p> <p>303-34 describe and demonstrate the means of propulsion for flying devices, using a variety of sources</p>

Drag

Outcome

Students will be expected to

- demonstrate methods for altering drag in flying devices and describe and show improvements in design (206-6, 301-18)

Elaborations—Strategies for Learning and Teaching

The unit could start with a Know–Want to Learn–Learned (K-W-L) activity that focusses on flight and aerodynamics. Students could brainstorm what they know and have experienced with respect to wind, air resistance, flying, bird and insect flight, and leaves falling. The “W” could be the question that they have and would like to investigate. This activity will help the teacher gauge students’ conceptions and help focus the investigations in the unit.

There are four forces acting on flying objects. Drag is the force that slows the flying device. Gravity is the force that pulls it towards Earth. Thrust is the force that propels. Lift is the force that keeps it up in the air.

Through classroom discussion, teachers can introduce the concept of drag and encourage students to ask questions about drag that could be investigated. As students pose questions, the teacher can model for students how to change the question to a testable form. For example, “How can I reduce the drag in my glider?” could be rephrased to “Will folding the wings in half reduce the drag?” Students should be able to see the difference between these two questions and write similar types of questions.

Drag is the force caused by air resistance. Air is invisible, so students need to be reminded that air has real substance and can affect things in many ways. They can feel moving air, or wind, simply by standing outside on a windy day. Even on a still day, when a person or object is moving, the effect of air resistance can be felt.

Students can brainstorm techniques and products used to reduce drag while walking (bending into the wind) or taking part in sports (streamlined helmets, bathing suits, haircuts, for example). Small windmill toys and pollen blowing around can be used to show how air can be used to move things. Students can time each other as they run the length of the gymnasium—the first time holding a large piece of Bristol board in front of them and the second time without to see the effect of wind resistance.

Students are so used to experiencing life with air that they have to stretch their imaginations to think of how things would be affected without it. Students can explore this idea by dropping sheets of paper and taking part in discussion with questions such as, What might cause the paper to flutter to the ground? What is holding it up? What would happen to the sheet if there were no air? They could time how long papers folded in different ways take to reach the ground, graph their results, and propose explanations for any trends they may see.

Drag

Tasks for Instruction and/or Assessment

Informal/Formal Observation

- Observation checklist (possible criteria):
 - student revises design
 - student is recording distance and length of time
 - student analyses the design with respect to distance travelled, time in the air, and other factors that they want to test

As the students move from trying to figure out the factors that affect drag (science) to designing stable, long-flying aircraft (technology), creativity should be encouraged. There is no fixed “right” design. Students should be encouraged to try a variety of designs and, as they test them out, analyse their effectiveness.

Possible criteria:

- student attempts to improve the glider’s performance
- student tries a wide variety of designs and is creative in approach to design
- student attempts to control the performance of the glider by making it turn, loop, or gain altitude (206-6, 301-18)

Resources/Notes

Activities from Appendix F

- Activity 18: My Parachute
- Activity 19: Reducing Drag

Print

- *Sci-Tech Connections 6*, Section A, pp. 10–24, 35–43 (17027)
- *Nova Scotia Science 6*, pp. 79–84 (18499)

Curriculum Link

- Math: GCO E

Drag (continued)**Outcome**

Students will be expected to

- demonstrate methods for altering drag in flying devices and describe and show improvements in design (206-6, 301-18)

Elaborations—Strategies for Learning and Teaching

The two main factors that affect the amount of drag are shape and texture. Students should compare the drag in various flying devices. They can make gliders using various shapes and textures of papers and see which ones travel the fastest (and therefore have the least drag) when released or launched (same student throwing glider with same force). This can be done by seeing which glider passes by a certain point first. Note that the one that stays in the air the longest does not necessarily have the least drag. Since air and water are both fluids, students could even try to show how shape affects drag by dragging objects with various shapes and textures under water and using a spring scale to measure the drag. Students could also design parachutes and see which ones stay aloft the longest.

Students should identify some variables and determine why variations in flight path and time exist. They can work on redesigning their flying devices to improve performance. There are many variables in these types of learning experiences, such as the force that the students use and air currents.

Students can also investigate methods for altering drag by examining various high-speed transportation devices, such as trucks or cars. They can also look at how airplane designs have become more streamlined over the years, examining designs like the Concorde or other high-speed planes and comparing them with other commercial airliners. This will encourage students to appreciate the role and contribution of technology in their understanding of the world.

Drag (continued)**Tasks for Instruction and/or Assessment***Performance*

- Construct a paper glider. Test, modify, and retest your design to reduce drag as much as possible. Record evidence (flight time, flight distance) demonstrating that drag has been reduced. Be prepared to discuss your modifications with your teacher and classmates. (206-6, 301-18)
- Using similar methods as the above, construct a paper glider that will turn left (or turn right or gain altitude or make a loop) as it flies. (206-6, 301-18)

Journal

- Modify the question, How can I reduce the drag in my glider? into testable hypotheses. (206-6, 301-18)

Paper and Pencil

- Suggest improvements to the design of this plane (truck, car, boat) that would decrease the amount of drag that it experiences. (Provide students with a picture of an older model airplane, truck, car, or boat). (206-6, 301-18)

Resources/Notes*Activity from Appendix F*

- Activity 20: My Flying Device

Lift and Wing Shape

Outcomes

Students will be expected to

- identify characteristics and adaptations from living things that have led to flight designs (104-3, 106-3, 300-21)
- plan and perform a fair test demonstrating the characteristics that influence lift on objects in flight (204-7, 301-17, 303-32)

Elaborations—Strategies for Learning and Teaching

Heavy, solid objects do not normally stay aloft. Discussions held throughout this unit will undoubtedly raise the question, How do heavy flying devices, like commercial planes, lift off the ground and fly?

Students can design various wing shapes using materials such as cardboard, paper, tape, and something to attach strings onto, such as a pencil. They can blow on these shapes using a straw held at varying angles and see how far the various shapes rise. Students should investigate the factors of both wing shape and angle of attack (the angle at which the air is blown at the wing or the orientation of the wing with respect to the air blowing on it) in their investigations.

Lift can also be achieved through temperature differences in air, since warm air is less dense than cold air. Hot air balloons are examples of how warm air rises to float on denser cold air. Students can investigate this by inflating garbage bags with the warm air from a hair dryer. Students can investigate the uses of solar balloons, which are made from material that warms the air in the balloon when exposed to the sun and gives the balloon its lift.

Part of students' designing process should involve an investigation into the shapes of the various insects and birds that fly. By noting shapes that make them more aerodynamic, students can try to incorporate similar shapes in their designs.

They can also investigate wing designs on aircraft and look at other features that can increase or decrease the angle of attack during the flight. If possible, a field trip to an airport or a flight museum would provide students with the experience of seeing the wing flaps move at first hand. Students could prepare a list of questions they wish to investigate as they examine a real plane and talk to informed personnel at the airport. Students can design paper airplanes that incorporate different types of flaps to see the effect that they have on the flight path of the flying device. Encourage students to work collaboratively while designing their flying devices.

Students may also find it interesting to explore different car designs that use the aerodynamic principles. Spoilers, for example, are designed so that cars hug the road.

Lift and Wing Shape

Tasks for Instruction and/or Assessment

Performance

- Design, test, evaluate, and modify a wing shape to achieve the best lift. Use questions such as, What worked?, What did not? Suggest changes you might make to achieve the best lift. (204-7, 301-17, 303-32)
- Compare the movements of two things (e.g., bird, insect) that naturally fly or glide, using illustrations, animations, personally narrated video clips, poetry, or dance. Include the unique structures or characteristics that enable this creature to fly. (104-3, 106-3, 300-21)

Paper and Pencil

- Write four jot notes that identify characteristics and adaptations that enable birds and insects to fly. Try to provide examples or pictures of aircraft that use similar features. (104-3, 106-3, 300-21)
- Draw and label diagrams of the profiles of at least two of your wings, indicating areas where improvements were made. As part of your completed diagram, answer the question, How is lift important to flight? (204-7, 301-17, 303-32)

Resources/Notes

Activities from Appendix F

- Activity 21: Hot Air Balloon
- Activity 22: Gliders and Lift
- Activity 23: Birds and Insects That Fly
- Activity 24: My Kite

Print

- *Sci-Tech Connections 6*, Section A, pp. 30–34 (17027)
- *Nova Scotia Science 6*, pp. 64–74, 84 (18499)

Curriculum Link

- Math: GCO E

Lift

Outcomes

Students will be expected to

- identify characteristics and adaptations from living things that have led to flight designs (104-3, 106-3, 300-21)
- identify and collect information using models that involve lift (205-5, 303-33)

Elaborations—Strategies for Learning and Teaching

Once students have seen the effect that different wing shapes have on lift, they can be introduced to explanations involving lift.

Students could construct experiences involving lift and give explanations as to what makes objects move as they do using this principle. Here are some examples.

- Suspend two ping pong balls from a metre stick across two chairs at the same level, about 6–10 cm apart, and predict how the balls will move when the students blow between them (Test their prediction.)
- Baseball curve balls also work using lift. Students can view a demonstration or video of throwing balls to get the most curve and do research to find out why throwing a baseball with a spin results in a curve ball.
- With the fingers of both hands, students can hold a single sheet of paper just below their lower lip. Allow the paper to bend and hang downward, then blow across the top surface of the paper.
- Identify everyday situations that illustrate lift, for example, the way long hair will fly out an open window of a moving car.

Investigations in wind tunnels show streams of air moving faster over the top of a wing, illustrating how wings get their lift. As air moves around the wing, there is a net force pushing the plane up (lift).

Students should elaborate on wind tunnels and/or computers that are appropriate for testing and designing aircraft. Students could use print, Internet, and other media to research the use of wind tunnels and computer simulations in designing wing shapes and airplane designs, both of which allow wings and airplanes to be tested safely.

Lift

Tasks for Instruction and/or Assessment

Performance

- Set up an activity, or create a visual or multimedia presentation, that illustrates lift. (Groups of students can set up stations around the class with their activity or presentation, and the class can circulate around the classroom to try out the various activities at each station.) (205-5, 303-33)

Journal

- Illustrate and label a situation that involves lift with aircraft. (205-5, 303-33)

Paper and Pencil

- Using point form, write brief answers to the following questions:
 - What is a wind tunnel?
 - How are wind tunnels used in aircraft design?
 - Why are wind tunnels appropriate methods of testing and designing aircraft? (104-3, 106-3, 300-21)

Presentation

- Create a presentation that shows pictures of wind tunnels and the investigations that are performed in them. (104-3, 106-3, 300-21)
- Make your own wind tunnel using a hair dryer and a shoe box with windows cut out on the side so you can see what is happening inside the box. Attach different-shaped wings and see how they are affected by the wind. (104-3, 106-3, 300-21)

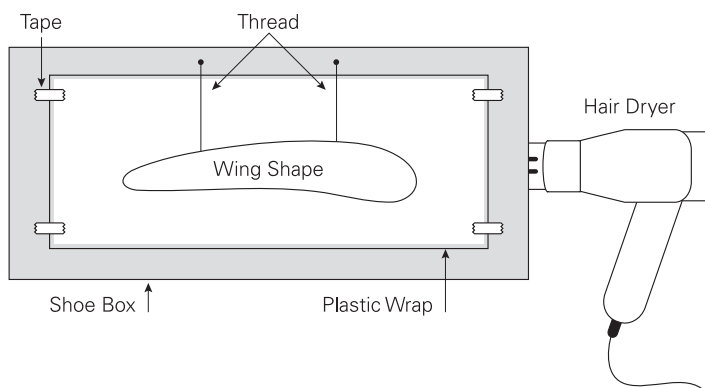

Resources/Notes

Activities from Appendix F

- Activity 25: Lift
- Activity 26: Aerodynamic Research

Print

- *Sci-Tech Connections 6*, Section A, pp. 8–12 (17027)
- *Nova Scotia Science 6*, pp. 74–78 (18499)

Thrust and Propulsion

Outcomes

Students will be expected to

- describe examples of technological design between aircraft and spacecraft and their influence on our lives (105-3, 107-9, 300-22)
- describe and demonstrate the means of propulsion for flying devices, using a variety of sources (303-34)

Elaborations—Strategies for Learning and Teaching

Students should investigate propellers. The third force that acts upon flying devices is thrust, the force that propels the flying device forward. There are two main types of propulsion: propulsion based on gases being projected away from the plane (pushing the plane through the air) and propulsion pulling the plane through the air.

Some early and present-day aircraft use propellers for thrust. Propellers turn in a way that pulls the air in front to the back, similar to a screw being twisted into wood. Propellers must have an atmosphere to work, since they rely on the resistance of air to provide the thrust. Students could make propellers, or they may be purchased from electronic or hobby stores. They may also use a propeller under water.

All of the flying objects explored in this unit so far have depended on air to fly. Ask the students for an explanation about spacecraft. Spacecraft cannot use propellers; they must make their own gas to shoot out to propel the plane forward. This is illustrated by blowing up a balloon and then letting it go. It will zoom around the room because it is being propelled by the escaping gas. Alternatively, straws could be attached to the balloon, with a thread or string threaded through the straws and attached to a far wall, and the balloons could be propelled along the string track. Teachers could challenge students to design the most stable craft that works by propulsion, such as rocket ships, jets, and space shuttles.

Students should examine designs for spacecraft and airplanes and note features that rely on an atmosphere (large wings, engines, propellers) and those that indicate the craft will be flying in space (small wings or rudders, large booster containers for fuel, as these are needed).

In the past, there were large differences between air and space craft, but increasingly, more flying devices (like space shuttles) are being developed that have the ability to fly both in space and in air and thus have features of both. Examples of Canadians who have contributed to flight are Wallace R. Turnbull from New Brunswick, who invented the variable-speed propeller; Robert Noorduyn from Québec, who designed the bush plane; J. D. McCurdy of Baddeck who built and flew the first aircraft in the British Commonwealth; and Alexander Bell who built the *Silver Dart* and several kites. Additional Canadian achievements in flight and space research include Bombardier, the Canadian Aerospace Agency, and the Avro Arrow.

Students can look at how airplane designs have become more streamlined over the years and examine designs like the Concord or other high-speed planes and compare them with the more commercial airliners. This will encourage students to appreciate the role and contribution of technology in their understanding of the world.

Thrust and Propulsion

Tasks for Instruction and/or Assessment

Paper and Pencil

- Write a paragraph or choose a graphic organizer that compares and contrasts thrust and propulsion. (303-34)

Presentation

- Create a display that illustrates a variety of aircraft showing developments from past to present day. Be sure your work has Canadian content. (105-3, 107-9, 300-22)
- In groups, design a poster that illustrates the difference between aircraft and spacecraft and how the space shuttle has features of both. Follow the outline shown below. (105-3, 107-9, 300-22)

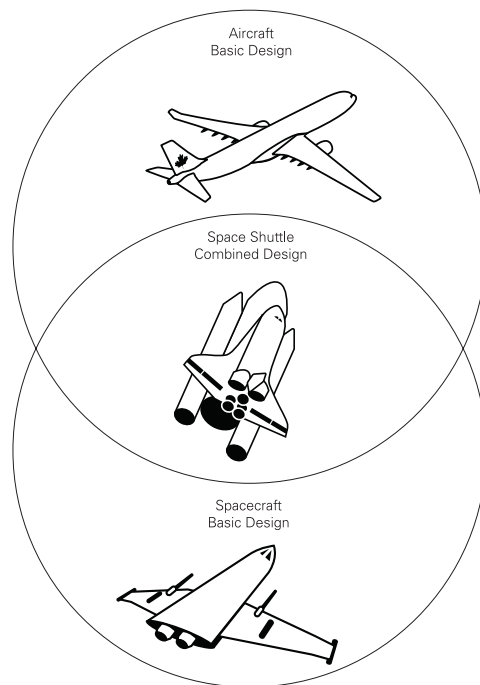

Resources/Notes

Activities from Appendix F

- Activity 27: Propulsion and Flying
- Activity 28: Aircraft Versus Spacecraft
- Activity 29: Airplanes and Spacecraft, Now and Then

Print

- *Sci-Tech Connections 6*, Section A, pp. 25–29 (17027)
- *Nova Scotia Science 6*, pp. 85–86, 88–96, 98–109, 111–117, 125 (18499)

Video

- *Awesome Airplanes* (35 min.) (22127)

Curriculum Link

- Language Arts
 - *Nova Scotia Science 6*, pp. 119–124 (18499)

Earth and Space Science: Space

Introduction

Space science involves learning about objects in the sky to discover their form, their movements, and their interactions. For students, developing a concept of Earth and space presents a new challenge. It requires extensive experience with models to explore relationships of size, position, and motion of different bodies. In learning about space, students come to appreciate that human ability to observe and study objects in space is now greatly enhanced by technology. Students learn that screwed and unscrewed probes and Earth-based devices are contributing to our knowledge of space and that new capabilities are being developed for monitoring Earth, for communications, and for the further exploration of space.

As the various components of the solar system are discussed and researched, students can learn about technologies, such as telescopes, satellites, and space probes, that have been developed to explore the solar system, the experiences that astronauts have as they live in space, and how space exploration has been undertaken as a largely international affair.

Focus and Context

The focus throughout this unit is inquiry. Students can create and use models to simulate and explore the interactions within the major components of the solar system and universe. By constructing models, the students can investigate, for example, the causes for the seasons. A second focus is on giving students opportunities to find up-to-date information about space exploration and about the various components of the solar system and constellations. Students will be exposed to electronic and print resources that can illustrate the wealth of knowledge that has accumulated about space and learn skills for searching out and personalizing this knowledge.

Science Curriculum Links

From Science 1, Daily and Seasonal Changes, students have been introduced to the concept of daily and seasonal cycles. In this unit on space, students will account for these cycles and expand their knowledge of space by studying the components of space. This topic will be studied in more depth in Science 9, Space Exploration.

Curriculum Outcomes

The following outcomes have been developed from the pan-Canadian outcomes in *Common Framework of Science Learning Outcomes K to 12*. See Appendix J for the original outcomes from which these were derived.

STSE/Knowledge	Skills	Knowledge
<p><i>Students will be expected to</i></p> <p>105-6, 205-8, 107-3 describe and compare how different societies have interpreted natural phenomena, using a variety of sources, to validate scientific knowledge</p> <p>106-3, 107-15, 206-4 describe and give examples of information and contributions that have led to new inventions and applications</p>	<p><i>Students will be expected to</i></p> <p>205-2, 300-23, 104-8 gather information, describe, and display the physical characteristics of components of the solar system</p> <p>206-5, 301-21 describe, based on evidence, and make conclusions about how astronauts are able to meet their basic needs in space</p>	<p><i>Students will be expected to</i></p> <p>301-19 demonstrate how Earth's rotation causes the day and night cycle and how Earth's revolution causes the yearly cycle of seasons</p> <p>301-20 observe and explain how the relative positions of Earth, the moon, and the sun are responsible for the moon phases, eclipses, and tides</p> <p>302-13, 207-2 identify constellations from diagrams, pictures, and/or representations of the night sky</p>

Space Exploration

Outcomes

Students will be expected to

- describe and give examples of information and contributions that have led to new inventions and applications (106-3, 107-15, 206-4)
- describe and compare how different societies have interpreted natural phenomena, using a variety of sources, to validate scientific knowledge (105-6, 205-8, 107-3)
- describe, based on evidence, and make conclusions about how astronauts are able to meet their basic needs in space (206-5, 301-21)

Elaborations—Strategies for Learning and Teaching

Teachers and students should describe how conceptions have resulted in changes from that of a flat Earth to an Earth-centred system to a sun-centred system. This unit could start with an open discussion with students about their conceptions of Earth and its place in the solar system. What is the shape of Earth and the motion of Earth relative to the sun, the moon, and the planets? Throughout this discussion, probe where the students got their information, and intersperse early conceptions of Earth and its place in the solar system. These early conceptions (flat Earth, the sun rotating around Earth) seem quite common sense in the absence of contrary evidence, and in fact, the idea that Earth actually revolved around the sun was met with considerable resistance when first proposed. What today's students may take for granted and not question was very controversial in its time.

Students should describe how people's perception of Earth's position has changed from a flat Earth to a round Earth, and from an Earth-centred system to a sun-centred system.

Students should speculate, discuss, and gather information about how astronauts meet their basic needs. One way to approach this is to ask students to describe their day and then, bit-by-bit, try to figure out how they would do the same things in space. What challenges would they face?

Students could research Canadian scientists and engineers who have contributed to the space program such as astronauts Marc Garneau, Roberta Bondar, Julie Payette, Chris Hadfield, Bob Thirsk, Steve MacLean, Dave Williams, and Bjarni Tryggvason and inventor, George J. Klein.

Students should describe examples of tools that have been developed and have improved our ability to explore the universe, such as binoculars, telescopes, the lunar buggy, the Canadarm, the Hubble telescope, space probes, and the space station. Students could also learn about products that were developed for space travel and have been applied to everyday use, such as Tang, freeze-dried food, and Velcro.

Many countries are involved in space exploration, and often teams are put together for various projects. Students could note the construction of the space station and investigations on space shuttle missions as examples of these types of international collaborative efforts.

Students could explore current investigations/observations in space, such as the movements of comets, space exploration missions, the origin of the solar system and universe, and the movement of asteroids.

Two excellent sources of information on current space initiatives are NASA's home page on the Internet, and the Canadian Space Agency. Students can access daily reports of space shuttle missions, see pictures from various space probes, and ask questions of astronauts, as well as many other educational features. An emphasis should be placed on Canadian contribution to space exploration.

Space Exploration

Tasks for Instruction and/or Assessment

Journal

- Imagine you are a Canadian astronaut. Over a one-week period, compose a daily journal entry as if you were on a space shuttle mission. Write about your personal observations while living and working in space. (206-5, 301-21)

Interview

- Do you think the space shuttle is an improvement over earlier rockets? Give evidence for your reasons. (106-3, 107-15, 206-4)

Paper and Pencil

- Research an astronaut you admire or would like to learn more about. If you had a chance to write to or meet him or her, what questions would you ask? (106-3, 107-15, 206-4)
- In the past, many people believed that Earth was the centre of the solar system. What information/evidence has caused people to change their belief? (105-6, 205-8, 107-3)

Resources/Notes

Activities from Appendix G

- Activity 41: Moving in a Space Suit
- Activity 42: Space Exploration around the World

Print

- *Sci-Tech Connections 6*, Section B, pp. 54–67 (17027)
- *Nova Scotia Science 6*, pp. 138–140, 141–143, 148–157 (18499)

Videos

- *Awesome Space* (35 min.) (22217)
- *Space Exploration: Ocean Exploration* (25 min.) (23113)

Relative Position and Motion of Earth, the Moon, and the Sun

Outcome

Students will be expected to

- demonstrate how Earth's rotation causes the day and night cycle and how Earth's revolution causes the yearly cycle of seasons (301-19)

Elaborations—Strategies for Learning and Teaching

Students can use models to show the effects of moving celestial bodies (use balls, globes, flashlights, or lamps to show how day and night occur, for example).

Before students can understand the causes of the seasons, they need to investigate the effect of the angle of the sun's rays on temperature. If possible, light meters can be used to investigate the difference in light intensity at various points on a globe or circular object when light from a lamp or flashlight is shone on it. Diagrams can also be drawn to show that the angle will cause the light to be spread out over a larger area and, therefore, that the light is not as concentrated and it will not be as warm.

Students can observe the differences in temperature at various times of the day and relate these differences to the angle of the sun. (This may replace the model activity above.)

Once students understand the effect the angle of the sun has, they can investigate the causes of the seasons by using four globes tilted on the axes and positioned so that the same geographic feature faces the lamp. The centre and the axis of each globe must be parallel to each other for this to work.

Relative Position and Motion of Earth, the Moon, and the Sun

Tasks for Instruction and/or Assessment

Performance

- Put a light in the middle of the room to represent the sun. A basketball (mark or paste something on it to represent the Atlantic provinces) or globe can represent Earth, and a tennis ball can represent the moon. Ask students to position or move Earth and/or the moon to simulate the following situations:
 - Position Earth so that it is night in the Atlantic provinces.
 - Position Earth so that it is summer in the Atlantic provinces.
 - Move Earth to show its path for one year (no rotation, just revolution).
 - Move Earth to show its motion for one day. (301-19)

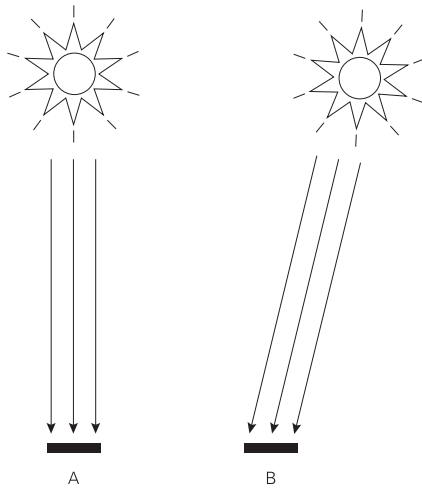

- For each diagram, explain how the angle of the sun may affect the temperature. (301-19)

Resources/Notes

Activities from Appendix G

- Activity 30: Our Moving Earth
- Activity 31: Changing Seasons
- Activity 32: Day and Night

Print

- Sci-Tech Connections 6*, Section 3, pp. 23–34 (17027)
- Earth*, DK Eye Wonder (17530)
- Nova Scotia Science 6*, pp. 158–161 (18499)

Relative Position and Motion of Earth, the Moon, and the Sun *(continued)*

Outcome

Students will be expected to

- observe and explain how the relative positions of Earth, the moon, and the sun are responsible for the moon phases, eclipses, and tides (301-20)

Elaborations—Strategies for Learning and Teaching

Models using globes, balls, and lamps or flashlights should also be used to illustrate the phases of the moon and eclipses. Students should be able to draw diagrams or hold models of Earth, the moon, and the sun in positions to show how the various phases of the moon occur and how a solar and lunar eclipse occur.

Students could look for evidence of tides (e.g., How high do you think the tides go? What signs do you see as evidence?) on a field trip to a tidal zone. Explanations of tides should be limited to simple models or diagrams that involve Earth and the moon. Other factors affect tides, such as the gravitational pull of the sun on Earth and the oceans, but these factors should be ignored for now or explored as an enrichment activity (neap tides, spring tides). Note in the diagram below, high tide occurs at points A and C, while low tides are at points B and D. As the moon revolves around Earth, the high tides move with it.

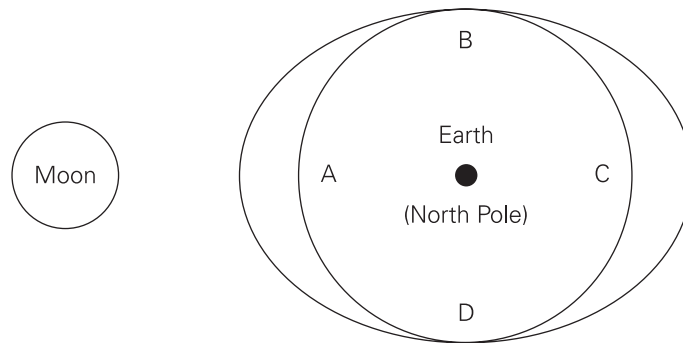

Diagrams are not nearly as useful as models, but they provide a simple framework for students who have a hard time visualizing exactly what is going on in a two-dimensional diagram. For example, they may think that point B is the North Pole, since that is the way they are used to seeing Earth in pictures. Since the diagram looks down on Earth, the North Pole is actually in the centre.

Students can observe the phases of the moon, the rise and fall of tides, and the sun's position over a period of time. Students are able to relate this to their models of Earth, moon, and sun.

Relative Position and Motion of Earth, the Moon and the Sun *(continued)*

Tasks for Instruction and/or Assessment

Performance

- Check your local newspaper or Internet site for tide times and heights (search key words: “tide table”). Keep track of high and low tide times and the tide heights for one week. E-mail a student in another community or Atlantic province and compare your tide data. Propose explanations for why there are differences in the times and heights. (301-20)
- Examine next month’s calendar page showing phases of the moon. Draw your predictions of the interim position/images of the moon between each phase shown. Check your predictions with actual observations or use an astronomy software program for similar results. (301-20)

Journal

- Every night for one month, draw a picture of the moon if it is visible, and date it. Identify the date of the full moon, half moon, new moon, and quarter moon. (301-20)

Resources/Notes

Activities from Appendix G

- Activity 33: Moon Watching
- Activity 34: Phases of the Moon
- Activity 35: Lunar Eclipse
- Activity 36: Solar Eclipse

Print

- *Sci-Tech Connections 6*, Section B, pp. 35–45 (17027)
- *Nova Scotia Science 6*, pp. 162–168 (18499)

Videos

- *Moon Dance: Spin around the Solar System* (19 min.) (23675)
- *The Sun: The Planets* (50 min.) (23114)

The Solar System

Outcome

Students will be expected to

- gather information, describe, and display the physical characteristics of components of the solar system (205-2, 300-23, 104-8)

Elaborations—Strategies for Learning and Teaching

Students should gather information about the sun, the planets, moons, comets, asteroids, and meteors. This learning experience could be done by various groups and presented to the whole class. Students should construct models that give them a concrete picture of the scale of the solar system and the interactions between the planets. Depending on the scales chosen, this model may be constructed in a classroom, in the gym, or outside in the schoolyard. A useful model uses various lengths of string to show the distance of a planet from a sun and different-sized balls or balloons to represent different planets. If students are given a ball (planet) and the string attached to the sun to hold on to, they can simultaneously revolve around the sun to simulate the planets in their orbits. Other students may be given other props to signify what they are, for example, a small ping-pong ball or a pea could signify an asteroid and then move throughout this model to show the path they might follow.

Students should be able to distinguish between the identified components in terms of the paths they follow (for example, Do they orbit the sun? Do they orbit a planet?), their general make-up (solid, liquid, and/or gas), and their ability to radiate light. Students should also be expected to know the names of the planets and be able to identify the planets closest to Earth. They should not be required to know the order of all nine planets, but could perhaps name the planets closest and furthest from the sun. The focus should be on introducing them to the concept of a solar system and then teaching them the skills to seek out specific information instead of memorizing it.

When exploring the solar system, students should develop the following understanding and knowledge:

- Describe the sun as the centre of the solar system and the main source of energy for everything in the solar system.
- Describe planets as bodies that move around the sun and do not give off their own radiation.
- State the names of all the planets and name the planets on either side of Earth.
- Identify examples of planets that are made from rocky materials and those that are made up of gases.
- Describe moons as bodies that move around the planets and do not give off their own radiation.
- Describe the general composition, relative size, appearance, and paths of asteroids, comets, and meteors.

The Solar System

Tasks for Instruction and/or Assessment

Performance

- In a group of two or three, construct a model from the suggested list below:
 - model of the moon rotating and revolving around Earth
 - model of another planet and its moon(s), illustrating the paths and relative size
 - model of the planets of the solar system and sun, showing relative size or distance from the sun
 - model that illustrates the difference between a rocky planet and one composed mostly of gases
 - model that illustrates the relative size, path, and composition of a comet, meteor, or asteroid
 (205-2, 300-23, 104-8)

Journal

- Describe the importance of the sun from a personal perspective. (205-2, 300-23, 104-8)

Interview

- Do all the planets have the same type of composition? What types of planets are there? (205-2, 300-23, 104-8)

Resources/Notes

Activity from Appendix G

- Activity 37: Planets in Our Solar System
- Activity 38: The Solar System

Print

- *Show Me! Teaching Information and Visual Texts, Grades 5–6*, pp. 68–71, 104–107 (13153)
- *Sci-Tech Connections 6*, Section B, pp. 10–22 (17027)
- *Earth, Sun, Moon*, National Geographic Reading Expeditions, Earth Science (13498)
- *Stars and Galaxies*, National Geographic Reading Expeditions, Earth Science (13498)
- *Exploring Space*, National Geographic Reading Expeditions, Earth Science (13498)
- *Space*, DK Eye Wonder (17519)
- *Nova Scotia Science 6*, pp. 145–147, 172–186 (18499)

Video

- *Solar Energy* (17 min.) (23503)

Curriculum Link

- Math: GCO D

The Solar System *(continued)*

Outcome

Students will be expected to

- gather information, describe, and display the physical characteristics of components of the solar system (205-2, 300-23, 104-8)

Elaborations—Strategies for Learning and Teaching

Students will select one of the components of the solar system to research using the Internet, software, videos, or other sources. If they research a planet, they can collect information on moons, the planet's surface temperature, or the amount of gravity. The focus should be on developing the skills to seek out the information and trying to make the facts they collect as relevant and real to them as possible. They can display their findings in project form. Alternatively, students could write a letter home describing their holiday on a planet, moon, or asteroid other than Earth and include in the description the key characteristics, drawings, or pictures of the planet. Students can participate in an "Invent an Alien" contest where they can use recyclable material to construct an alien that could survive on a planet other than Earth, or they can write a story about this alien, its experiences, and its adaptive features. Students can draft a travel brochure to a planet.

Software and Internet sites are available that can provide an excellent, motivating source of information about the components of the solar system.

Students should examine, critically, a variety of information sources on the solar system. Sources include science fiction books, television programs, Internet sites, and scientific books and magazines. There is a wide variety of science fiction shows on television. Students could evaluate these shows to try to pick out fact from fiction in some of these episodes. This can connect to language arts outcomes related to critical literacy. An interesting project is to show old science fiction shows and discuss how some of technologies used in those shows were not even invented at that time, but are now commonplace. Another source of fact versus fiction can be explored by students or teachers reading science fiction and factual accounts of phenomena (such as the apparent canals on Mars). Discussions can ensue on the merits and purpose (entertainment versus information) of each account. It can also help to highlight the concept that as technology improves, ideas in science constantly evolve. Hubble, who first used his telescope to look at Mars, concluded that it was crisscrossed with canals, which led him to conclude that it had intelligent life forms that used advanced technologies. This spurred on scientific investigation to determine the nature of these canals, which led in turn to a better theory as to the origin of the canals.

The Solar System *(continued)*

Tasks for Instruction and/or Assessment

Paper and Pencil

- What is the difference between the orbit of a planet and the orbit of a moon? (205-2, 300-23, 104-8)
- Using various sources to obtain information, design and produce a brochure on your topic. Topics may be a component of the solar system, a current event in space travel or exploration, or a technology used to explore space. (205-2, 300-23, 104-8)

Presentation

- A class chart will be created as a wall chart. This chart will be a reference for the unit and may be added to as the unit progresses. (205-2, 300-23, 104-8)

Our Solar System

Name	Relative Size to Earth	Length of Orbit	Solid, Liquid, and/or Gas	(add categories as needed)
Sun				
Moon				
Mars				

Resources/Notes

Stars and Constellations

Outcomes

Students will be expected to

- identify constellations from diagrams, pictures, and/or representations of the night sky (302-13, 207-2)
- describe and compare how different societies have interpreted natural phenomena, using a variety of sources, to validate scientific knowledge (105-6, 205-8, 107-3)

Elaborations—Strategies for Learning and Teaching

Obviously, viewing the night sky is not going to be possible during school hours. Depending on weather conditions, the stars may not be visible for long periods of time. Whenever possible though, students should be encouraged to observe the night sky and identify patterns and differences over the evening and from night to night. As a home activity, students could pick out one star/constellation and note its position at the same time each night. Students should not be asked to memorize large numbers of constellations. Teachers may want to focus on one or two that are visible at that time of the year so that students can recognize them and show them to others in their household. Given a picture of the night sky, students can invent their own constellations and name them. This will emphasize to them that constellations are human inventions and that different places around the world have defined different constellations with a variety of names.

Students can try to identify constellations using pictures of the night sky. Students can make their own planetarium. Select constellations and, using construction paper, poke holes for the design. Shining light through the holes will project the constellations on a screen.

Students can investigate, using electronic and print resources, how the stars have been used by different cultures over time and how various constellations got their names. Fishers, explorers, and astrologers have used the position of the stars to help them. Students can investigate some of the ways that stars have been used in the past, and, if possible, try using the same techniques to see if they have merit. Examples of cultures that could be explored are the Celts, the Aztecs, and the Egyptians. Ways in which cultures have used the positions of the stars include determining the appropriate time to plant and harvest crops, navigating the oceans, and/or foretelling significant events. This may link to specific curriculum outcomes addressed last year in Social Studies 5, Ancient Societies.

Stars and Constellations

Tasks for Instruction and/or Assessment

Performance

- Using dark construction paper, draw a constellation, and mark the stars that define it. Using a pin or sharp point of a pencil or pen, put holes in the paper where the stars appear. Using an overhead projector, share your constellation with the class. (105-6, 205-8, 107-3)

Journal

- Three times this month, on clear nights, record your observations of the night sky. Create your own constellation, name it, and draw it in your journal. (105-6, 205-8, 107-3)

Interview

- Do we always see the same stars when we look out at night? Do the patterns of stars change over the year? (302-13, 207-2)

Paper and Pencil

- Research and write a brief report on a constellation. Refer to the origin of its name and its importance to ancient and/or modern cultures. (105-6, 205-8, 107-3)
- Research how the Egyptians, the Aztecs, and other cultures used the sun and stars to explain natural phenomena. (105-6, 205-8, 107-3)

Resources/Notes

Activity from Appendix G

- Activity 39: My Constellation
- Activity 40: Star Light, Star Bright

Print

- Sci-Tech Connections 6*, Section B, pp. 46–53 (17027)
- Nova Scotia Science 6*, pp. 187–192 (18499)

Videos

- Stars of the Universe* (19 min.) (23100)

Curriculum Link

- Social Studies: SCO 6.4.1.

Life Science: Diversity of Life

Introduction

Through this unit, students will be able to recognize that living things can be subdivided into smaller groups. As an introduction to the formal biological classification system, students will focus on plants, animals, and micro-organisms. Students will have the opportunity to learn about an increasing variety of living organisms, both familiar and exotic, becoming more precise in identifying similarities and differences among them.

Focus and Context

Inquiry is the focus in this unit, with an emphasis on observation and classification. Students should be involved in closely observing living things (plants, animals, and micro-organisms), noting their features and constructing classification schemes that group organisms with like features together. They should also be introduced to formal classification schemes with a main focus on animal classifications. Students will gain an appreciation for the diversity of life within their local habitat, their province, and the world and, through fossil studies, over time.

Classifications Introduced in This Unit

This diagram illustrates the organisms and classifications addressed in this unit. Note that this is not a complete, formal biological classification scheme.

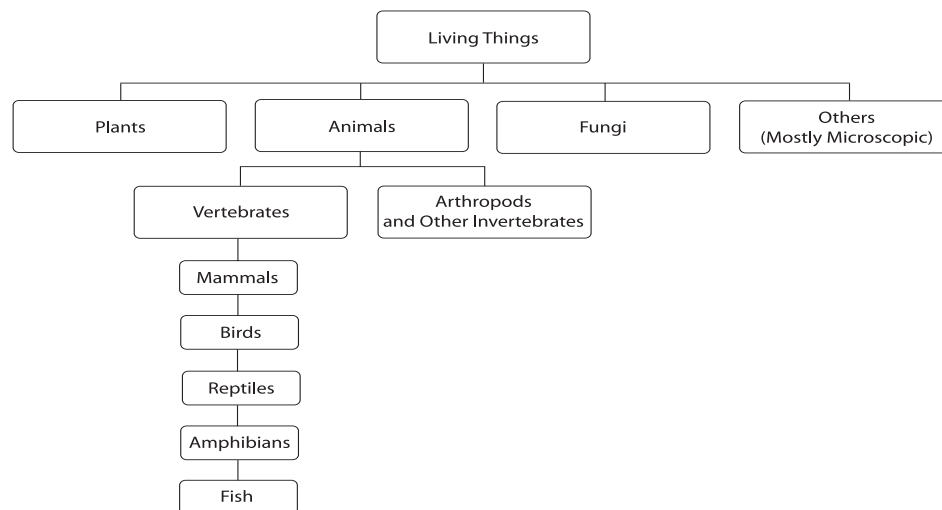

Science Curriculum Links

Students have investigated the needs and characteristics of living things in Science 1, explored growth and changes in animals in Science 2, and plant growth in Science 3.

In this unit, students continue to sort living things through an introduction to formal classification systems. This unit, and the concepts developed in the Habitats unit in Science 4, will give students the foundation for the Science 7 unit Interactions within Ecosystems.

Curriculum Outcomes

The following outcomes have been developed from the pan-Canadian outcomes in *Common Framework of Science Learning Outcomes K to 12*. See Appendix J for the original outcomes from which these were derived.

STSE	Skills	Knowledge
<p><i>Students will be expected to</i></p> <p>107-3, 107-6 provide examples of how science and technology have been used in identifying and controlling micro-organisms by different people around the world</p> <p>107-11, 207-4, 301-16 identify changes in animals over time and research and model the work of scientists</p> <p>204-1, 108-8 propose questions and gather information about the relationship among the structural features of plants and animals in their environments and identify the positive and negative impacts of humans on these resources</p>	<p><i>Students will be expected to</i></p> <p>205-8, 300-18 classify common arthropods using a variety of sources</p> <p>206-1, 206-9, 300-15 create and analyse their own chart or diagram for classifying and describe the role of a common classification system</p>	<p><i>Students will be expected to</i></p> <p>204-8, 300-19, 302-12 identify and use appropriate tools to examine micro-organisms and describe how they meet their basic needs</p> <p>300-16, 300-17 classify animals as vertebrates or invertebrates and compare the characteristics of mammals, birds, reptiles, amphibians, and fishes</p> <p>301-15, 104-5, 204-6 classify and compare the adaptations of closely related animals and plants living in their local habitat and in different parts of the world and discuss reasons for any differences</p>

The Role of a Common Classification Scheme for Living Things

Outcome

Students will be expected to

- create and analyse their own chart or diagram for classifying and describe the role of a common classification system (206-1, 206-9, 300-15)

Elaborations—Strategies for Learning and Teaching

Students should start this unit by going out to a local habitat (school area, forest, seashore, pond, meadow, park, wooded area) to observe and record the wide variety of species that they see. Using other sources, such as magazines, videos, field guides, and other media, they can examine the diversity of life. From their observations and research, students can classify their organisms into groups based on characteristics they select. They may use fairly specific characteristics or more general groupings related to insects, plants, fungi, trees, animals, or combinations of each. Students can then attempt to sort them using different characteristics and come up with a different classification scheme. As they compare their schemes with others in the class, they will see that their classification schemes will not be the only way to classify organisms. Through this learning experience, students should discover the fact that classification schemes are human inventions.

Teachers could initiate discussion around the necessity for a common classification scheme in order for scientists to communicate using the same language and terminology. There are more than one million species of living things, with the possibility of millions more yet to be discovered. This raises questions about how we can simplify the presentation of information about so many different species. Discussion should lead to the advantages of grouping or classifying organisms on the basis of common characteristics and the necessity of a common classification scheme. These discussions encourage students to appreciate the role of science in their understanding of the world.

Background: Classification schemes have changed over the years as new information has accumulated. An early classification scheme had all organisms divided into two kingdoms: plants and animals. A more recent classification scheme divides all organisms into five kingdoms (monerans, protists, fungi, plants, and animals). At this level, students should be able to identify three of the five kingdoms: animals, plants, and fungi. The other two kingdoms can be grouped together as being micro-organisms. These will be further distinguished in high school biology.

Review the Unit Overview for the extent to which organisms will be classified in this unit. The terms **kingdom**, **phylum**, and **species** may be used, but it is not necessary to go into the full formal classification scheme for individual species. It is enough to show the common characteristics of some phyla and look at some examples of species that belong to them.

Dichotomous classification is used in science. Students may start with this approach.

The Role of a Common Classification Scheme for Living Things

Tasks for Instruction and/or Assessment

Performance

- Collect leaves in your neighbourhood. After careful observation, decide on a way to group the leaves you have collected. Record characteristics that you used to group the leaves and then draw pictures of the leaves in each group or paste the leaves into your book in the appropriate place. (Classification should be done with a variety of living things, such as insects and flowers.) (206-1, 206-9, 300-15)

Journal

- On my trip to the farm (zoo, park, garden centre, beach, etc.), I saw many types of organisms ...

Students can continue to write about their experience, recording their points of interest during the trip. Encourage them to organize their journal entries into the following sections: animals, plants, fungi (if appropriate). (206-1, 206-9, 300-15)

Interview

- Did your group classify things the same way other groups did? Is there more than one way we can classify organisms? (206-1, 206-9, 300-15)
- If every scientist grouped living things the way they wanted and called their groups by different names, what problems would it cause when they talked to each other about their ideas? (206-1, 206-9, 300-15)

Resources/Notes

Activities from Appendix H

- Activity 46: Classification Systems

Print

- *Sci-Tech Connections 6*, Section D, pp. 14–23 (17027)
- *LifeScience*, National Geographic Reading Expeditions (13497)
- *Birds*, DK Eye Wonder (17529)
- *Bugs*, DK Eye Wonder (17528)
- *Mammals*, DK Guide (17515)
- *Reptiles*, DK Eye Wonder (17521)
- *Nature: Animals, Plants and Birds in New Brunswick, Nova Scotia, and Prince Edward Island* (17506)
- *Nova Scotia Science 6*, pp. 202–203 (18499)

Videos

- *The Kingdom of Animals: From Simple to Complicated* (21 min.) (23297)
- *The Kingdom of Plants* (16 min.) (23299)
- *Plants in Nova Scotia* (10 min.) (V2429)

Curriculum Links

- Math: SCOs F1, F2, and F9

The Animal Kingdom: Vertebrates and Invertebrates

Outcomes

Students will be expected to

- classify animals as vertebrates or invertebrates and compare the characteristics of mammals, birds, reptiles, amphibians, and fishes (300-16, 300-17)
- classify common arthropods using a variety of sources (205-8, 300-18)

Elaborations—Strategies for Learning and Teaching

In this section, students are introduced to classifying animals as vertebrates (animals with backbones) or invertebrates (animals without backbones).

Students can attempt to classify the animals from their list of organisms as vertebrates or invertebrates. (Most of the organisms from the habitat study will probably be invertebrates—invertebrates outnumber vertebrates in diversity and number, and most of the vertebrates will have, in all probability, remained well hidden.) They can also classify other animals that they have seen from magazines, journals, software, books, field trips to zoos, natural history museums, or aquaria. Students should have opportunities to see reconstructed backbones or models of backbones and compare and contrast them with exoskeletons of lobsters or crabs.

From their list of vertebrates, students, individually or in groups, can classify the organisms further. Challenge the students to find a variety of ways to group their vertebrates. The students can report their schemes to the class and why they chose them. As long as their schemes are based on set characteristics, they are valid classifications. However, for global communication, a common classification scheme has to be agreed upon. At some point, the common groups of vertebrates (fish, amphibians, reptiles, birds, and mammals) should be introduced, and their common characteristics identified. As much as possible, students should be given opportunities to study live and preserved organisms or view videos of animals that are representative of these groups.

The invertebrates will not be completely classified in this unit. Of approximately 30 invertebrate phyla, this unit will distinguish only the arthropods (many-jointed legs). Students could collect specimens and/or pictures of common arthropods and bring them to class where they could observe and record characteristics of this group. Insects make up a large portion of arthropods and provide interesting and motivating specimens for investigations. Students can investigate these organisms outdoors or set up artificial indoor habitats for them, such as ant farms or jars with dirt, leaves, and food or wood scraps. Other arthropods that can be explored are lobsters and crabs, centipedes and millipedes, and spiders.

The Animal Kingdom: Vertebrates and Invertebrates

Tasks for Instruction and/or Assessment

Performance

- From drawings, specimens, pictures, or a list of animals, classify each organism as a vertebrate or invertebrate and then further classify them as mammals, birds, reptiles, amphibians, fish, arthropods, or other invertebrates. (Provide students with drawings, pictures, or a list of animals.) (300-16, 300-17)
- Examine pictures or specimens of arthropods. Investigate the relationship between an arthropod's mouth parts and its feeding behaviour. How does the arthropod's mouth parts help it feed? Record your findings. (Students should provide sketches and description.) (205-8, 300-18)

Journal

- In your journal, draw pictures and describe some of the arthropods that you have investigated. Did you find it easy to see the similarities in these different organisms? What similarities did you find first? Were there any features that you thought all arthropods had, but then found out that they didn't? (205-8, 300-18)

Interview

- Students are shown pictures or specimens of skeletons of various vertebrates, including some fish, birds, and mammals. Ask students, How are these skeletons alike? How are they different? Note whether students indicate that animals that can look very different on the outside can have very similar skeletons. (300-16, 300-17)

Paper and Pencil

- What questions would you ask to determine if an animal is a mammal, bird, reptile, fish, or amphibian? (300-16, 300-17)

Resources/Notes

Activities from Appendix H

- Activity 47: The Animal Kingdom
- Activity 48: Vertebrates, Invertebrates
- Activity 49: Arthropods
- Activity 50: Models of Vertebrates or Invertebrates

Print

- *Sci-Tech Connections 6*, Section D, pp. 24–31 (17027)
- *Nova Scotia Science 6*, pp. 187–192, 226–227 (18499)

Videos

- Animals around Us Series (13 min. each): *Birds: What Are They?* (V2505); *Fish: What Are They?* (V2506); *Mammals: What Are They?* (V2507)
- *At Home with Zoo Animals* (15 min.) (23179)
- *Bugs Don't Bug Us* (35 min.) (23269)
- Champions of the Wild Series (25 min. each): *Sharks* (22677); *Grizzlies* (22678); *Orcas* (22679); *Polar Bears* (22680); *Right Whales* (22681)
- Eyewitness Series (34 min. each): *Bird* (22447); *Reptile* (22454); *Skeleton* (22456); *Amphibian* (22467); *Insect* (22469)

Curriculum Links

- Math: SCOs F1, F2, and F9

Micro-organisms

Outcomes

Students will be expected to

- identify and use appropriate tools to examine micro-organisms and describe how they meet their basic needs (204-8, 300-19, 302-12)
- provide examples of how science and technology have been used in identifying and controlling micro-organisms by different people around the world (107-3, 107-6)

Elaborations—Strategies for Learning and Teaching

When using microscopes, students should start with hands-on instruction on the proper way to use and care for a microscope. Microscope video cams can be connected to a large-screen television, computer monitor, or projection unit to show the whole class the features of micro-organisms. Hand lenses and mini microscopes can be used to view microscopic characteristics.

A magnifying learning centre that also included illustrations of other magnifying devices, such as Intel electronic microscopes, would be ideally suited for this purpose.

Students should describe how micro-organisms meet basic needs. Samples of pond water, compost material, aquarium glass scrapings, or prepared slides can provide specimens for study. When viewing features of the micro-organisms, such as flagella or cilia, identify those that are used to help the micro-organisms meet their needs. Commercially prepared slides of micro-organisms, some stained so that features are more visible, can be used. Micro-organisms can also be explored through the use of videos that show how micro-organisms move, meet their other basic needs such as food, air, and water, as well as the role some of these micro-organisms have in disease, composting, and other areas.

Science and technology examples of the growth of micro-organisms can include areas such as sanitation, food preservation, disease control, and the home. Students should discuss how micro-organisms can be both advantageous (e.g., food digestion in the bowel, composting, sanitation, food preservation, and disease control) and disadvantageous (e.g., spreading many germs and diseases) to humans.

Students could discuss examples of technological innovations that have been developed to protect against unwanted micro-organisms (such as cleaning solutions, processed lunch packages, canned goods, preserving jars, and antibacterial hygienic products like toothpaste, creams, and soaps). In the section Adaptations and Natural Selection, the impact of using antibacterial products may be discussed again. These activities provide an excellent opportunity for students to appreciate and connect the role and contribution of science and technology in their lives.

Micro-organisms

Tasks for Instruction and/or Assessment

Performance

- Using a prepared slide, use a microscope (or microviewer) to focus the slide properly. When you have finished adjusting the microscope, ask your teacher to check your technique. Draw a sketch of what you see. (204-8, 300-19, 302-12)

Journal

- Create a two-page spread in an information text that gives information on two micro-organisms: one that can be harmful to humans and one that can be good for humans. Use diagrams, labels, and cross-sections. Collect or draw pictures of these micro-organisms and research the features in these micro-organisms that help their movement and feeding. (107-3, 107-6)

Paper and Pencil

- **Research Assignment:** Using a specific example, (e.g., strep throat, *E. coli* in food products) describe the roles of both science and technology in controlling harmful bacteria in one of the following: sanitation, food preservation, and disease control. (Students should differentiate between scientific study of the organisms and technological products and techniques that have been developed to control the organisms.) (107-3, 107-6)

Presentation

- Prepare a poster showing some pictures or drawings of magnified objects using magnifying glasses, microscopes, and electron microscopes. Under each picture, identify the object that was magnified, the instrument that magnified it, and the extent to which it was magnified (for example, 40×). (204-8, 300-19, 302-12)
- Collect the labels and brochures of disinfectants and antibacterial hygienic products. Make a poster displaying labels of products that are used to protect against micro-organism growth. (107-3, 107-6)
- Develop a short skit on good and bad bacteria. This could be video-recorded or presented live. (107-3, 107-6)

Resources/Notes

Activities from Appendix H

- Activity 51: Magnification
- Activity 52: Micro-organisms
- Activity 53: Micro-organisms—Helpful or Harmful

Print

- *Sci-Tech Connections 6*, Section D, pp. 41–55 (17027)
- *Nova Scotia Science 6*, pp. 212–219 (18499)

Adaptations and Natural Selection

Outcomes

Students will be expected to

- propose questions and gather information about the relationship among the structural features of plants and animals in their environments and identify the positive and negative impacts of humans on these resources (204-1, 108-8)
- classify and compare the adaptations of closely related animals living in their local habitat and in different parts of the world and discuss reasons for any differences (301-15, 104-5, 204-6)
- identify changes in animals over time and research and model the work of scientists (107-11, 207-4, 301-16)

Elaborations—Strategies for Learning and Teaching

During classroom discussion, encourage students to ask questions about the adaptations and structural features of organisms. For example, students might ask, Why does this frog have such a long tongue? Questions like these should be rephrased to What does the frog use his long tongue for? and used as the basis of further investigation. Students can study the organisms they found in their field study to see the features that they have that help them live in their particular habitat.

Students should explore similar organisms that live in different parts of the world (e.g., arctic hare and snowshoe hare) and inquire about the structural differences in these organisms and how these structural differences help them to survive and grow in their environment.

Students can inquire into the conditions that have led to the endangerment of various species. Students can investigate local and global examples to see how information about population size is determined. Students can gather information about natural attrition of species. This will encourage students to be aware of and develop a respect and understanding for the welfare of living things.

Students should explore what types of fossils have been found and the theories that exist about what caused particular organisms (e.g., dinosaurs) to become extinct. Field trips to fossil exhibits or local sites, the use of software, the Internet, print resources, and audiovisual resources would also be good sources of information about fossils.

Students should also investigate the tools and techniques paleontologists use to acquire knowledge about fossils. The focus is on how paleontologists do their work (finding and cleaning fossils, trying to piece together skeletal remains, trying to estimate the age of the fossils) and contrast with some of the techniques and tools available (computer-generated drawings of dinosaurs, carbon dating so that a more accurate age of the fossil can be determined). The goal is for students to see that improvements in scientific techniques and technological tools can lead to better scientific knowledge. The goal is not to be able to explain how these new techniques and technological tools actually work.

This section provides an excellent opportunity for students to explore a variety of science-related careers related to the diversity of life. Connections can be made to the study of fossils through exploration of Rocks and Minerals in Science 4 and Ancient Societies in Science 5.

Adaptations and Natural Selection

Tasks for Instruction and/or Assessment

Performance

- Carefully examine fossils. Draw the fossil and write a story about its journey. (107-11, 207-4, 301-16)

Journal

- Write about your personal feelings regarding endangerment of local species. (204-1, 108-8)

Paper and Pencil

- Choose a pair of animals below and find out in what part of the world they are usually found. Describe one difference between each of them and describe how that difference helps that animal survive in its habitat. Examples that might be used include brown bear and polar bear, red fox and arctic fox, red-eyed tree walker frog and poison dart frog, or beluga whale and orca whale. (301-15, 104-5, 204-6)
- Write a report about paleontologists. Include a description of what they study, some of the techniques they use in their work, and how their work has contributed to our understanding of life on Earth in the past. (107-11, 207-4, 301-16)

Presentation

- Choose an organism and describe the structural features that enable it to survive in its environment. Focus on the structural features that the organism has for moving, obtaining food, and protecting itself. Describe how these help it to survive in its environment. Present your findings to the class using drawings, pictures, video, or skit. (204-1, 108-8)
- From a list of endangered species, choose one and research it. What factors have caused its endangerment? What is being done to protect it? Work in pairs and present your findings to the class. (204-1, 108-8)
- Create a poster showing extinct organisms that lived on Earth long ago and similar organisms that live on Earth today. (107-11, 207-4, 301-16)

Resources/Notes

Activities from Appendix H

- Activity 43: Trees All around Us
- Activity 44: Plants in My Habitat
- Activity 45: Animals in My Habitat
- Activity 54: Structural Features of Organisms
- Activity 55: Endangered Species
- Activity 56: Paleontologists

Print

- Sci-Tech Connections 6*, Section D, pp. 32–40, 56-61 (17027)
- Nova Scotia Science 6*, pp. 234–247, 250–253 (18499)

Curriculum Links

- Health Education: SCO C4.1
- Social Studies: SCOs 6.2.3 and 6.5.3

Appendices

Appendix A: Equipment Lists

School Materials

This suggested school list consists of items that each school should have to do the hands-on, minds-on science activities outlined in this guide. It does not include items in the classroom supplies.

	Electricity	Flight	Space	Diversity of Life
Supply List				
alligator clips	X			
attribute rings				X
batteries, D-cell, regular and rechargeable	X			
battery holders, size D	X			
bells, electric	X			
cameras, digital				X
clay (including white), modelling, Plasticine		X	X	X
clipboards				X
combs, plastic	X			
compasses			X	
computers (with Internet access)	X	X	X	X
construction paper (including black)		X	X	
copper strips	X			
counters, two-sided			X	
elastic bands			X	
electric buzzers	X			
electrical devices (fans, lights, flashlights, buzzers, bells, speakers)	X			
extension cords	X			
flashlights			X	
generators, hand-held	X			

	Electricity	Flight	Space	Diversity of Life
globe			X	
hair dryer		X		
Kidspiration				X
kites		X		
lamps (for 100-watt bulbs)			X	
light bulbs, mini	X			
light sockets, mini	X			
lights, flourescent (mini and mini spiral)	X			
lights, LED	X			
magnifiers, hand-held				X
measuring tapes		X		
metre sticks		X	X	
microscope slides				X
microscopes (including Intel)				X
mixer	X			
models, airplanes and spacecraft		X		
multimeter	X			
nails	X			
paper clips	X	X		
reference books	X	X	X	X
solar cells	X			
speakers				X
staples	X			
stopwatches		X		
Styrofoam balls, various sizes (including 10-cm diameter)			X	
switches	X			
ticket board		X		
timers			X	

	Electricity	Flight	Space	Diversity of Life
tissue paper		X		X
trowels				X
tweezers				X
washers, large		X		
wire, various types (including bell)	X			
wire strippers	X			
wooden stir sticks			X	
zinc strips	X			

Classroom Supplies

This suggested classroom list consists of items that each class should have to do the hands-on, minds-on science activities outlined in this guide. It does not include items listed in the other lists.

	Electricity	Flight	Space	Diversity of Life
Supply List				
brass fasteners	X			
chalk			X	
eraser	X			
glue		X		
paint			X	X
paint brushes			X	X
paper (including 11 x 17)	X	X	X	X
pencils	X			
Plasticine				X
scissors		X	X	
tape (including masking)		X	X	

	Electricity	Flight	Space	Diversity of Life
Consumables				
aluminum foil	X			
balloons (various shapes)	X	X		
Bristol board			X	
dowels, thin		X	X	
garbage bags, plastic		X		
lemons	X			
paper (including brown, kraft)	X	X		
papier mâché			X	
plaster of Paris				X
plastic		X		
poster board			X	
potatoes	X			
rice, puffed	X			
salt	X			
straws, plastic	X	X		
string		X		

Recyclables and Collectibles

This suggested recyclables and collectibles list consists of items that each class should have to do the hands-on, minds-on science activities outlined in this guide. It does not include items listed in the other lists.

	Electricity	Flight	Space	Diversity of Life
Supply List				
cans			X	
cardboard	X	X		
confetti	X			
containers, clear	X			
fabric, various types	X			
nickels	X			
paper towel rolls				X
pennies	X			
plastic bags		X		
rocks/stones			X	
sticks			X	
toy vehicles		X		
wood	X			

Appendix B: Video Resources

Education Media Library

The Education Media Library has over 5,000 titles in its video collection. All programs have been evaluated for curriculum use and are intended to support the Nova Scotia Public School Program. They may be used by teachers and others engaged in public education in Nova Scotia. Public performance rights have been purchased so that all videos can be shown in classroom settings to students and educators.

The media library offers video loans and video-dubbing services. Loan videos have an assigned number that begins with the number 2 (e.g., 23456). These videos may be borrowed. The videos that are available through dubbing begin with a V (e.g., V1123). The media library makes a copy of these videos, which is then retained by the client. Dubbing services are provided for the nominal recovery cost of the videocassette on which the program is taped. Tape prices range from \$1.44 for a 20-minute tape to \$2.59 for a two-hour tape. Programs can be stacked onto one tape (e.g., four 30-minute programs onto one tape) or dubbed on separate tapes.

The Learning Resources and Technology website, <http://lrt.EDnet.ns.ca>, provides a rich variety of curriculum-related resources to help teachers in their classrooms. Teachers can search the video database, find out about educational software, search the database of curriculum-related websites, download curriculum catalogues, access workshops on web safety, and find tips on integrating technology into the classroom.

Title	Description
Physical Science: Electricity	
<i>Electrical Current: Light Optics</i> (23116) 50 min., 1998	This tape has two 25-minute programs. In <i>Electrical Current</i> , get amped up when Bill Nye, the science guy, gets a charge explaining watts up with electricity.
<i>Creating and Controlling Current Electricity</i> (22912) 13 min., 1991	Electricity is the flow of electrons. Current electricity is the controlled flow of electrons. This video covers the concepts of circuits, conductors, insulators, atomic structure, energy conversion, and wet- and dry-cell batteries. A teacher's guide with simple experiments is included.
Physical Science: Flight	
<i>Awesome Airplanes</i> (22127) 35 min., 1994	How do planes work? Find out as this video takes you on a tour of a small plane, see each part, and visit a cockpit of a huge 747.
Earth and Space Science: Space	
<i>Awesome Space</i> (22217) 35min., 1994	This video takes you on a voyage to look at actual blast-offs from the launch pad, gets up close to see what rockets and space ships really look like, see the skylab that the astronauts lived in while they floated in space, and watch the first time astronauts walked on the moon and see the ship that took them there.
<i>Moon Dance: Spin around the Solar System</i> (23675) 19 min., 2001	The moon and Earth formed at about the same time from the same type of materials. Ever since, the pair has been dancing through space and time together. This program investigates the ways the moon and Earth affect each other. It covers a variety of lunar topics such as ocean tides, the phases we see from Earth, and the Apollo moon landings.
<i>Solar Energy</i> (23503) 17 min., 1996	This program from the series Science in Action is divided into three parts: capturing solar energy, transferring solar energy, and storing solar energy.
<i>Space Exploration: Ocean Exploration</i> (23113) 50 min., 1998	This tape has two 25-minute features. Join Bill Nye, the science guy, as he finds out what it is like to be an astronaut and the tools humans invented to explore space.
<i>Stars of the Universe</i> (23100) 19 min., 2000	In this program you take a tour to encounter and examine some of the amazing celestial objects of our universe. Topics include the stars of the universe, star clusters, the Big Bang, inside the stars, and types of stars.

Title	Description
<p><i>The Sun: The Planets</i> (23114) 50 min., 1998</p>	<p>This tape has two 25-minute segments. <i>The Sun</i>: Go stargazing with Bill Nye as he visits his favourite hot spot—the sun. Bill Nye, the science guy, sheds light on solar flares and eclipses. <i>The Planets</i>: Prepare for an out-of-this world experience as Bill Nye gets up close and personal with each of the solar system’s planets and moons.</p>
Life Science: Diversity of Life	
<p>Animals around Us Series (V2505–V2507) 13 min. each, 2001</p>	<p>Students will travel the world with naturalist Paul Fugua and explore the world of birds, fish, and mammals respectively in three separate videos: <i>Birds: What Are They?</i> (V2505); <i>Fish: What Are They?</i> (V2506) <i>Mammals: What Are They?</i> (V2507)</p>
<p><i>At Home with Zoo Animals</i> (23179) 15 min., 1992</p>	<p>Visit zoo animals in captivity in their native habitats. Learn how zoos attempt to meet animals’ needs by mimicking natural environments. Learn how zoo-bred endangered animals are reintroduced into the wild.</p>
<p><i>Bugs Don’t Bug Us</i> (23269) 35 min., 1991</p>	<p>This program introduces many of the common invertebrates that share our work. Explore the tiny world of insects, spiders, and other invertebrates with children. See close up how they move and eat.</p>
<p>Champions of the Wild Series (22677–22681) 25 min. each, 1997</p>	<p>This spectacular series features endangered animals and the Canadian champions dedicated to saving them, filmed around the world. A brief resource guide is listed on each video jacket. There are five separate videos: <i>Sharks</i> (V22677), <i>Grizzlies</i> (22678), <i>Orcas</i> (22679), <i>Polar Bears</i> (22680), and <i>Right Whales</i> (22681).</p>
<p>Eyewitness Series (22447, 22454, 22456, 22467, 22469) 34 min. each, 1994</p>	<p>Eyewitness is a series of half-hour videos about the natural world of wild animals. Titles that support this unit are <i>Bird</i> (22447); <i>Reptile</i> (22454); <i>Skeleton</i> (22456); <i>Amphibian</i> (22467); <i>Insect</i> (22469)</p>
<p><i>The Kingdom of Animals: From Simple to Complicated</i> (23297) 21 min., 1995</p>	<p>Rich live-action imagery excites students as they learn some very basic facts about the incredible diversity that exists in the animal kingdom. Starting with one-celled animals like protists, this program examines a variety of animal phyla: sponges, sea anemones, spiny-skinned animals, flatworms, mollusks, anthropods, and vertebrates.</p>
<p><i>The Kingdom of Plants</i> (23299) 16 min., 1993</p>	<p>This video examines the major branches of the plant kingdom.</p>
<p><i>Plants in Nova Scotia</i> (elementary version) (V2429) 10 min., 2000</p>	<p>This program is an overview illustrating the diversity of native plant life in the province, as well as basic distinctions between its many categories. Also available in French (V2431).</p>

Appendix C: Performance Assessment

A comprehensive evaluation of a student's progress in science should include a performance-based assessment. Areas for consideration may include

- problem comprehension
- co-operative learning
- problem solving
- equipment use
- communication of results

The rubric on the following page may be used for performance-based assessment. Ideally, a student will be assessed every few weeks. (One or more students may be observed during each activity.) The child is informally observed during the activity, and the observed levels of achievement are highlighted on the rubric. The dated rubrics may then be added to the child's assessment portfolio and referred to for evaluation. Levels of performance and progress are easily tracked and any areas of concern identified.

The use of a clipboard and highlighter allows for ease of recording as observations are made.

Performance Assessment Rubric

Name:	Date:
Activity:	
Problem Comprehension	
4	has a complete understanding of the problem
3	understands most of the problem
2	understands some of the problem
1	tries but does not understand the problem
0	makes no attempt to understand the problem
Co-operative Learning	
4	consistently encourages work toward the group goals with skill and sensitivity
3	fulfils his or her individual role with skill and sensitivity and without prompting
2	fulfils his or her individual role with sensitivity but needs occasional prompting
1	contributes only when prompted and needs reminders regarding sensitivity
0	refuses to work as a group member and/or shows no consideration for others
Problem Solving	
4	has a plan that could lead to the correct solution
3	follows the basic procedure with minor errors or omissions
2	partially follows the correct procedure but with major errors
1	plans inappropriately
0	makes no attempt to solve the problem
Equipment Use	
4	accurately uses all appropriate tools to gather data
3	effectively uses some of the appropriate tools to gather data but with minor errors
2	attempts to use the appropriate tools, resulting in inaccurate data
1	does not use the appropriate tools
0	makes no attempt to collect data by using the tools
Communication of Results	
4	gives a concise explanation of the method with a conclusion based on the data collected
3	gives a satisfactory explanation of the method with a conclusion based on the data collected
2	gives an incomplete explanation of the method and/or a conclusion only partially supported by the data
1	gives an explanation that cannot be understood/makes no reference to the data
0	gives no explanation/gives no conclusion/presents no data

Appendix D: Journals and Logbooks

Journals and logbooks are a part of many occupations and as such are highly reflective of the world of work. Many highly successful people keep a daily journal as a habit that helps them develop insights into their work. A journal can include sketches, diagrams, notes, quotes, questions, excerpts, and drafts. Scientists recording this way are keeping track of all of their observations and so on. This is their “private science.”

The journal or logbook may be used to develop a final product—such as a report, design, profile, fictional text, or dramatization—or it may be a way of tracking progress and developing ideas and insights. The final product is the young scientist’s “public science.”

Students need to see the value of their science-log writing, not only through frequent responses from the teacher, including assessments that “count,” but also through assignments that provide linkages to previous and subsequent learning or that meet specific learning and/or personal needs for the student.

Since the journal or logbook can contain very personal thoughts and ideas, stimulated by thought-provoking questions, the teacher must make provisions to honour the confidentiality of students’ work, except where legally required to do otherwise.

Elements of the following journal assessment rubrics can be used in various combinations.

Journal Comment Rubric

Name:	Comments
Ideas <ul style="list-style-type: none"> • interprets and analyses issues • describes new insight(s) 	
Critical Thinking <ul style="list-style-type: none"> • identifies assumptions underlying an issue, problem, or point of view • probes beneath the surface for layers of significance • explains an issue from multiple perspectives 	
Ethical Reasoning <ul style="list-style-type: none"> • uses rules or standards of right/wrong or good/bad to guide the debate/reflection 	
Personal Experience <ul style="list-style-type: none"> • connects insights/thoughts to personal experience 	
Development <ul style="list-style-type: none"> • develops the content thoroughly 	

Journal Scoring Rubric

	1	2	3	Assessment	
				Student	Teacher
<i>Ideas</i>	states facts	interprets and/or analyses an issue	interprets, analyses, and describes a new insight/new insights		
<i>Critical Thinking</i>	identifies a stated issue, problem, or point of view	identifies assumptions underlying an issue, problem, or point of view	questions assumptions underlying an issue, problem, or point of view		
<i>Critical Thinking</i>	responds to a stated issue, problem, or point of view	identifies more than one layer of significance	probes beneath the surface for multiple layers of significance		
<i>Critical Thinking</i>	describes a single response to a situation or problem	describes several responses to a situation or problem	sees the implications of alternative responses to a situation or problem		
<i>Critical Thinking</i>	explains an issue from one perspective	explains an issue from more than one perspective	explains an issue from multiple perspectives		
<i>Ethical Reasoning</i>	does not consider ethical aspects of issues	recognizes and often applies standards/ rules	uses rules or standards of right/ wrong or good/ bad to guide the debate/ reflection		
<i>Personal Experience</i>	does not personalize his or her journal	makes some connection to personal experience	connects insights and thoughts to personal experience		
<i>Development</i>	develops the content minimally	develops the content adequately	develops the content thoroughly		
Name:			Score:		

Appendices E–H

Introduction

In the following four appendices (E–H), you will find activities you may wish to use or modify to support student achievement of specific curriculum outcomes for Science 6. These activities are referenced under column four, Resources/Notes, in each unit on the two-page spreads and are meant to add to other hands-on learning experiences that you may provide to address curriculum outcomes.

You may also find well-written, easy-to-follow activities and curriculum links to science in the print resources in, or available to, schools through the Nova Scotia School Book Bureau. (See Appendix I.)

Appendix E: Activities for Physical Science: Electricity

Activity 1: Electrical Dangers

Outcome

Students will be expected to

- describe how electricity has led to inventions and discuss electrical safety features at work and at play (107-9, 106-4, 108-2, 303-31)

Assessment

- Students are able to demonstrate an understanding of electrical dangers.

Questions

- What are some of the electrical dangers that one could encounter?
- What are some of the electrical dangers you could encounter in your home or at school?

Materials

- electrical devices
- pictures of electrical devices
- pictures of power lines
- sockets
- extension cords
- Kidspiration
- Activity 1: Electrical Dangers, My Investigations

Procedure

In groups, have students discuss electrical dangers. Have them record their discussions. Have each group share their ideas and make a master list for the class. Show students various electrical devices and have them describe possible electrical dangers. Have them illustrate the device and describe the danger beside it. For example, a frayed electrical cord, flying a kite near power lines, or an electrical socket. Kidspiration could be used to illustrate examples and to create a web diagram.

Visual Art: Students could make an electrical safety poster illustrating dangers and safety issues associated with the use of electricity.

Activity 1: Electrical Dangers, My Investigations

Device	Danger	Safety

Activity 2: Understanding Electrical Dangers

Outcome

Students will be expected to

- describe how electricity has led to inventions and discuss electrical safety features at work and at play (107-9, 106-4, 108-2, 303-31)

Assessment

- Students are able to demonstrate their ability to develop and present a performance that identifies electrical dangers at work or at play.

Question

- How can you develop a scene that will demonstrate to younger children the dangers of electricity?

Materials

- none

Procedure

This learning experience is designed to help students respect their understanding of an outcome through aesthetic expression. Allow the students to work in groups and have each group decide an electrical danger or dangers they want to present. When designing their performance, they should also include how being aware of electrical dangers can also provide a safe approach to electricity. Students should be given the opportunity to perform their scenes for other classes.

This learning experience could be done during English language arts time.

Activity 3: Exploring Static Electricity

Outcome

Students will be expected to

- make predictions and investigate static electricity and draw conclusions based on evidence (104-5, 204-3, 204-7, 205-9, 206-5)

Assessment

- Students are able to demonstrate static electricity.

Question

- What are some examples of static electricity?

Materials

- balloons
- plastic straws
- small fluorescent light bulb
- confetti or small pieces of paper
- combs
- various types of fabric

Procedure

This learning experience will act as a review for the concepts students learned about static electricity in Science 3. Have students try to move confetti by creating static electricity. Have them illustrate and describe what they observed. A teacher demonstration would be to charge an object and touch the end of a fluorescent light bulb. Have students describe what they observed.

Teacher's Note: When you touch a statically charged object to the end of a fluorescent light bulb there should be a spark of light inside the bulb. This demonstration would need to be done in a darkened room.

Activity 4: Analysing Static Electricity

Outcome

Students will be expected to

- make predictions and investigate static electricity and draw conclusions based on evidence (104-5, 204-3, 204-7, 205-9, 206-5)

Assessment

- Students are able to experiment to see if the strength of the static charge is dependent on the material used to create it.
- Students are able to demonstrate and explain if static electricity is able to travel through solids and/or liquids.

Questions

- Does the material used to create static electricity affect the strength of the charge?
- How does the number of times you rub an object affect the strength of the electrical charge?
- Does static electricity travel through solids and liquids?

Materials

- balloons
- plastic straws
- small fluorescent light bulb
- confetti or small pieces of paper
- combs
- various types of fabric (such as wool, cotton, polyester)
- wood
- water in a clear container
- Activity 4: Analysing Static Electricity, My Investigations

Procedure

Part 1: Strength of Static Electricity

Discuss with students how they might test the strength of a static electrical charge. From these discussions, have students test their ideas.

Teacher's Note: Students could see if the number of times they rubbed a plastic straw with a material increased the number of items they could pick up. They could compare this to the type of material used. Students could also see if the direction in which they rubbed the plastic straw made a difference in the strength of the straw. Students may create their own chart or use the one included with this activity.

Part 2: Have the students put confetti or small pieces of paper on top of various surfaces (paper and wood, various thicknesses). By putting a charged object under the material, students can observe if the confetti moves. If it does, does that mean that static electricity can travel through that material? Have students illustrate their results.

Activity 4: Analysing Static Electricity, My Investigations

Strength of Static Electricity

Object Being Charged	Material Used to Charge the Object	Number of Times the Object Was Rubbed with the Material	Type and Number of Items Being Picked Up

How did the number of times the object was rubbed affect the number of items that were picked up?

Which materials created the strongest charge? How do you know?

Illustrate and label one of your tests.

Activity 5: Static Electricity—Attraction and Repulsion

Outcome

Students will be expected to

- make predictions and investigate static electricity and draw conclusions based on evidence (104-5, 204-3, 204-7, 205-9, 206-5)

Assessment

- Students are able to demonstrate objects being attracted to a charge and repelled from a charge.
- Students demonstrate a working knowledge and understanding of the terms **attraction** and **repulsion**.

Questions

- What do the terms **attraction** and **repulsion** mean?
- How can one demonstrate what these terms mean using static electricity?
- What is meant by positive and negative charges?

Materials

- balloons
- plastic straws
- small fluorescent light bulb
- confetti or small pieces of paper
- combs
- various types of fabric (such as wool, cotton, or polyester)
- wood
- water in a clear container
- puffed rice
- Activity 5: Static Electricity—Attraction and Repulsion, My Investigations

Procedure

Have students tie thread to a piece of puffed rice. Have them tie the other end of the thread to a ruler and hang the thread and the puffed rice over the edge of a desk so that the hanging rice does not touch the desk.

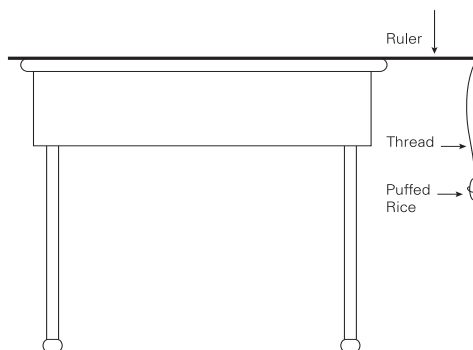

Discuss with students what they think will happen when a charged object (plastic straw) comes near the puffed rice. Record their answers on the board. Have the students try various materials and have them record their findings. After each group has finished, make a chart on the board and have them fill in their results. Were the results the same? Were they different?

If the results were not the same, discuss with the class what might have caused the different results. Have students try the activity again using the same method. For example, have students rub the straw in one direction and the same number of times. Use a new straw for each material. If the straw touches the puffed rice, have students change the charge by touching it with their hand prior to the next test.

Compare the results of each group again and see if they are the same or different. Discuss with students positive and negative charges and how like charges will attract and unlike charges will repel.

Activity 5: Static Electricity—Attraction and Repulsion, My Investigations

Attraction and Repulsion, Trial 1

Object Being Charged	Material Used to Charge the Object	Attract	Repel	Nothing Happened

Attraction and Repulsion, Trial 2

Object Being Charged	Material Used to Charge the Object	Attract	Repel	Nothing Happened

Compare the results of the two trials. How are they the same? How are they different?

What might have caused the different results?

Activity 6: Simple Circuits

Outcome

Students will be expected to

- compare a variety of electrical pathways by constructing simple circuits, series circuits, and parallel circuits and illustrate them with appropriate symbols (303-23, 303-25, 207-2)

Assessment

- Students are able to make a light bulb light up using wire and a battery.
- Students are able to determine what a simple circuit is.

Questions

- How can we light up a light bulb?
- What materials would be needed to light up a light bulb?
- What is a simple circuit?

Materials

- mini light bulbs
- mini light bulb sockets
- batteries
- battery holders
- alligator clips
- wire
- wire strippers

Procedure

Discuss with the students how they think a light bulb is lit up. Ask them what types of materials they would need to test their ideas. Provide students with the materials to make a complete simple circuit. Have them illustrate their circuits and answer the questions above.

Teacher's Note: The path taken by an electrical current is a complete circuit.

Activity 7: Insulators and Conductors

Outcome

Students will be expected to

- perform activities that compare the conductivity of different solids and liquids (205-3, 300-20)

Assessment

- Students are able to differentiate between a conductor and an insulator.
- Students are able to explain the importance of conductors and insulators.

Questions

- What is a conductor?
- What is an insulator?
- How can one tell the difference between a conductor and an insulator?
- Where are conductors and insulators used?

Materials

- mini light bulbs
- mini light bulb sockets
- batteries
- battery holders
- alligator clips
- wire
- wire strippers
- various conductors and insulators, such as paper, cloth, wire, foil, pennies, nickels, water, salt water, eraser, and lemon juice
- Activity 7: Insulators and Conductors, My Investigations

Procedure

Have students share their ideas on what they think an insulator is and what a conductor is. Develop a working definition for both terms and post them in the classroom. Ask the students what types of tests they could do to see if a material is a conductor or an insulator. Provide students with a variety of items to test and have them record their results. Follow-up the activity with discussions on the importance of insulators and conductors and where they are used.

Teacher's Note:

- conductor—allows an electric current to pass through it
- insulator—does not allow an electric current to pass through it
- Although wood may not appear to let an electric current pass through it using 1.5 volt batteries, wet wood, for example, is a conductor and not an insulator.

Activity 7: Insulators and Conductors, My Investigations

Insulators and Conductors

Item	Conductor	Insulator

What happened to the light bulb when a conductor was used to make a complete circuit?

What happened to the light bulb when an insulator was placed in the simple circuit?

Where would insulators be used?

Where would conductors be used?

Explain how both insulators and conductors are important in the use of electricity.

Diagram of one of the tests that were tried.

Activity 8: Series and Parallel Circuits

Outcome

Students will be expected to

- compare a variety of electrical pathways by constructing simple circuits, series circuits, and parallel circuits and illustrate them with appropriate symbols (303-23, 303-25, 207-2)

Assessment

- Students are able to construct a series circuit.
- Students are able to construct a parallel circuit.
- Students are able to distinguish and explain the different properties of series and parallel circuits.

Questions

- What is a series circuit?
- What is a parallel circuit?
- What properties distinguish the difference between a series and parallel circuit?

Materials

- mini light bulbs
- mini light bulb sockets
- batteries
- battery holders
- alligator clips
- wire
- wire strippers

Procedure

Ask students if they have heard of the terms **series** and **parallel** circuits. Next, guide a learning experience whereby students

- use two lights to make a circuit so that when one light is removed, the other light goes out
- use two lights to make a circuit so that when one light is removed, the other stays on

Have the students compare the brightness of the bulbs from the two situations. After the students have completed the comparison, discuss with them which one was a series circuit and which was a parallel circuit. Have them draw and label an example of each. Students may wish to add more light bulbs to expand their circuits. Discussions should take place as to where series and parallel circuits are used.

Teacher's Note:

- series circuit—when there is only one path for the electrical current to follow
- parallel circuit—when the same voltage is applied to every circuit element, and there are several paths for the electrical current to follow

Activity 9: Switches

Outcome

Students will be expected to

- describe the role of switches in electrical circuits and identify materials that can be used to make a switch (303-24, 204-8)

Assessment

- Students are able to explain the uses of switches.
- Students are able to make a circuit using a switch.

Questions

- What is a switch?
- What are switches used for?
- How do switches work?

Materials

- mini light bulbs
- mini light bulb sockets
- batteries
- battery holders
- alligator clips
- wire
- wire strippers
- materials to make switches (such as aluminum foil or cardboard)
- switches

Procedure

Discuss with students where they have seen switches and what they were used for. Record the list of examples on chart paper or on the board. In this learning experience, students can use commercial switches (such as knife switches) for science activities and/or they can make their own. Have students illustrate and label their circuits using switches. Discussions on electrical safety and switches should take place.

Teacher's Note:

- open circuit—when an electrical current is not able to travel along a path; the electrical path is broken
- closed circuit—when an electrical current can follow a complete path from its source through a conductor and back to the source

Activity 10: Making Electromagnets

Outcome

Students will be expected to

- investigate and describe the relationship between electricity and magnetism using electromagnets and electric generators (204-1, 303-27, 303-22)

Assessment

- Students are able to create an electromagnet.
- Students are able to explain what some of the factors are that affect the strength of an electromagnet.

Question

- What is an electromagnet?
- How can the strength of an electromagnet be increased?

Materials

- batteries
- battery holders
- alligator clips
- nails (various sizes)
- insulated wire
- paper clips
- staples
- Activity 10: Making Electromagnets, My Investigations

Procedure

Discuss with students what they think an electromagnet is and what it is made of. Students should be given the opportunity to explore making an electromagnet. Once they have made an electromagnet, pose the question, How can you make your electromagnet stronger?

Have students present their ideas and then test them. Have them share their findings with the class.

Activity 10: Making Electromagnets, My Investigations

Size/Type of Nail	Number of Batteries	Number of Wraps of Wire	Objects Being Picked Up	Number of Objects Picked Up

Illustration of an electromagnet:

Description of the materials and strategies used to make a stronger electromagnet:

Activity 11: Uses of Electromagnets

Outcome

Students will be expected to

- investigate and describe the relationship between electricity and magnetism using electromagnets and electric generators (204-1, 303-27, 303-22)

Assessment

- Students are able to exhibit and explain devices that use electromagnets.

Questions

- Where can electromagnets be found?
- What types of devices use electromagnets?

Materials

- various devices that use electromagnets (such as a mixer, a speaker, or a doorbell)
- batteries
- battery holders
- alligator clips
- reference books
- computers with Internet access

Procedure

In this learning experience, students should be given the opportunity to carry out research on the types of devices that use electromagnets. Students could present their information to the class.

Activity 12: Investigating Electrical Circuitry

Outcome

Students will be expected to

- demonstrate how electricity in circuits can produce light, heat, sound, motion, and magnetic effects (303-26)

Assessment

- Students are able to use a variety of devices to explain how electric circuits can produce sound, heat, light, and motion.

Question

- What types of devices use electricity to produce sound, heat, light, and motion?

Materials

- various devices that produce sound, heat, light, and motion (devices can be brought in by students)
- batteries
- battery holders
- alligator clips
- wire

Procedure

This learning experience is designed to have students bring in electrical devices to experiment with. These devices should have a minimum voltage requirement of 1–3 volts, so they can be run on a battery-powered circuit. Students should be given the opportunity to demonstrate their devices to the class and explain how the electric circuit makes them work. Students should be given the opportunity to explore their devices before presenting to the class. Examples of electrical devices are fans, lights, flashlights, buzzers, bells, and speakers, to name a few.

Activity 13: Solving an Electrical Problem

Outcomes

Students will be expected to

- demonstrate how electricity in circuits can produce light, heat, sound, motion, and magnetic effects (303-26)

Assessment

- Students are able to create and illustrate a device using electric current and explain how it works.
- Students are able to assess and analyse other students' devices/projects and make constructive suggestions and/or observations regarding the device/project.
- Students are able to show the step-by-step process they followed to make their device/project.

Questions

- What types of devices use electricity to produce sound, heat, light, and motion?
- What will the device/project represent?
- What materials will you need to make your device/project?
- What problems did you encounter? How did you solve them?

Materials

- various devices that produce sound, heat, light, and motion (devices can be brought in by students)
- batteries
- battery holders
- wire
- items students need to make their projects

Procedure

Part 1: For this learning experience, students bring in electrical devices to experiment with. Students should be given the opportunity to demonstrate their devices to the class and explain how the electric circuit makes it work. Students should be given the opportunity to explore their devices before presenting to the class. Examples of electrical devices are fans, lights, flashlights, buzzers, bells, and speakers, to name a few.

Part 2: This learning experience can be done in class or at home. However, to do a true assessment of a student's problem-solving skills and to take into account those students who may not have materials at home, this project should be done at school. Students could work in groups or individually. Review with students the electrical concepts they have learned about. Have them discuss the type of device/project they want to do. From these discussions, have them draw a diagram of the devices/projects they want to produce and the materials they will need to build them. As the students are making their devices/projects, have them record problems they had and how they solved them. When the devices/projects are completed, have the students demonstrate them to the class.

Activity 13: Solving an Electrical Problem, My Investigations

Name of device/project: _____

Name (and partner(s)): _____

Diagram of the project or device I am going to make. Label parts and materials.

Materials I will need to make my device/project:

Parent Signature: _____

Where I am going to get the materials I need:

Problem(s) that I encountered:

How I solved the problem(s):

The task the device was designed to do:

Electrical components that are part of my device:

Design changes:

Final illustration of the device:



Electrical Device/Project

Student: _____ Device/project: _____

Student's Partner(s): _____

Project Work	Comments
Stayed on task	
Developed a device/project	
Made a list of materials needed	
Made an illustration of device	
Came prepared with materials	
Produced the device/project	
Discussed problems that arose	
Redesigned model to accommodate the problems encountered, if necessary	
Presented the device/project to the class	
Was able to answer questions from the class	

Activity 14: Electricity and Inventions

Outcome

Students will be expected to

- describe how electricity has led to inventions and discuss electrical safety features at work and at play (107-9, 106-4, 108-2, 303-31)

Assessment

- Students are able to carry out research on inventions that relate directly to electricity.
- Students are able to describe how safety is an important factor when using electricity.

Questions

- What types of electrical devices are used in your home?
- How has society become increasingly dependent on electricity?
- What is meant by the term **electrical safety**?

Materials

- reference books
- computers with Internet access

Procedure

Students should begin by discussing the types of inventions that have been developed for the use of electricity, how society has become more dependent on it, and how to use electricity safely. Students should be given the opportunity to research an electrical invention. The research should cover the following areas:

- who and when it was invented
- how it has helped and/or hindered society
- where it is used
- safety features built into the device

Activity 15: Generators

Outcome

Students will be expected to

- investigate and describe the relationship between electricity and magnetism using electromagnets and electric generators (204-1, 303-27, 303-22)

Assessment

- Students are able to distinguish between an electromagnet and a generator.
- Students are able to explain the importance of generators, how they are used, and where they are used.
- Students are able to produce an electrical current using a generator.

Questions

- What characteristics do a generator and an electromagnet have in common?
- How does a generator produce electricity?
- Where are generators used?

Materials

- commercially produced hand-held generators
- mini light bulbs
- mini light bulb sockets
- wire

Procedure

Have students discuss their concept of what generators are and what they do. Have each group share their ideas with the class. Have students look at the hand-held generators and make a list of the components that they observe. Have students connect the generators to the light bulbs and, by turning the handle, produce an electric current to light the bulb. Have students discuss how generators are important to society. Students may have flashlights at home that have mini generators in them to produce a current.

⚠ Teacher's Note: Caution should be taken when using the hand-held generators so that students do not get a shock from them.

Activity 16: Sources of Energy

Outcome

Students will be expected to

- explain various methods by which electricity is generated, including renewable and non-renewable (105-3, 303-28, 303-29)

Assessment

- Students are able to demonstrate ways to produce electricity.
- Students are able to distinguish between renewable and non-renewable sources of electricity.

Questions

- How is electricity produced?
- What do the terms **renewable** and **non-renewable** mean in relation to electricity?

Materials

- copper strips
- zinc strips
- lemons or potatoes
- multimeter
- solar cells
- dry cell batteries
- rechargeable batteries
- wire

Procedure

Part 1: Discuss with students the terms **renewable** and **non-renewable** as they relate to electricity. Have students discuss various forms of renewable energy to produce electricity (wind, water, solar) and non-renewable sources (fossil fuels, batteries). Ask students to discuss the importance of renewable electrical energy sources.

Part 2: This activity can be either a teacher- or student-centred activity. Using a copper and zinc strip embedded in a lemon or potato, connect wires to them and then to a multimeter that can detect an electric current. Discuss with students the type of battery this is (chemical).

Have students use solar cells to produce an electric current. Have them discuss the advantages and disadvantages of solar electrical power.

Activity 17: Using Electrical Energy Wisely

Outcome

Students will be expected to

- describe how our actions could lead to reducing electrical energy consumption in our environment (108-5, 108-8, 303-30, 106-3)

Assessment

- Students are able to elaborate on the importance of conserving electricity.
- Students are able to develop and use strategies to conserve electricity in their homes and at school.

Questions

- What is meant by the term **conservation of electrical energy**?
- What has brought about the need for society to be more aware of and to practise conservation strategies?
- What can you as an individual do to help conserve electricity?
- What devices have been developed to help conserve electricity?

Materials

- reference books
- computers with Internet access
- examples of devices that have been made to help reduce the amount of electrical use (such as LED lights or mini spiral fluorescent lights)

Procedure

This learning experience will provide students with an opportunity to learn about and promote conservation of electrical energy.

Part 1: Have students discuss what is meant by conservation of electricity. Have them put their ideas on chart paper for the rest of the class to see.

Part 2: Have students discuss the importance of conservation of electricity.

Have them put their ideas on chart paper for the rest of the class to see.

Part 3: Have students make a list of ways they could conserve electricity in their homes and at school. Have students identify electrical energy-saving devices in their homes or in advertisements in papers or magazines (for example, appliances that have the “Energy Star” label on them). Students could develop an ad campaign or posters promoting conservation of electrical energy around the school, at home, within their school board, or in businesses.

Part 4: Have students do research focussing on the types of electrical energy-saving devices that have been developed and where/how they are used.

Appendix F: Activities for Physical Science: Flight

Activity 18: My Parachute

Outcome

Students will be expected to

- demonstrate methods for altering drag in flying devices and describe and show improvements in design (206-6, 301-18)

Assessment

- Students are able to explain and demonstrate ways to increase drag by using a parachute.
- Students develop and demonstrate an understanding of the term **drag**.

Questions

- What is meant by the term **drag**?
- How can drag be increased to slow an object as it is falling?
- How does a parachute increase drag?
- Where are parachutes used?

Materials

- string
- plastic (grocery bags or garbage bags)
- cloth
- weighted objects (such as large washers, bolts, miniature vehicles)
- scissors
- Activity 18: My Parachute, My Investigations

Procedure

Discuss with students what happens when a weighted object is dropped. Ask students how the speed of the dropped object could be reduced. From these discussions, have students share where parachutes are used and for what purpose.

Have students hold their weighted object in the air and time how long it takes for it to fall. Then have students design a parachute and attach it to their object. Have them time how long it takes for the object to fall using a parachute.

Have students discuss what effect drag had on reducing the speed at which the object fell.

Students could change the size of the parachute and/or the length of the string to see what difference, if any, the changes made in the speed at which the object fell.

Activity 18: My Parachute, My Investigations

	Trial 1	Trial 2	Trial 3	Trial 4
Speed/time that the object took to fall without a parachute				
Speed/time that the object took to fall with a parachute				

Materials used to make the parachute:

Illustration/design of the parachute:

How did the speed at which the object fell differ when using a parachute? What do you think caused this to happen?

Activity 19: Reducing Drag

Outcome

Students will be expected to

- demonstrate methods for altering drag in flying devices and describe and show improvements in design (206-6, 301-18)

Assessment

- Students are able to demonstrate an understanding of the concept related to drag.
- Students are able to describe and demonstrate the importance of reducing drag.

Questions

- How have scientists and engineers reduced drag in automobiles and trucks?
- What negative effect would drag have on the performance of a vehicle?
- How can drag be reduced?
- How does reducing drag in vehicles help one to understand drag in flying devices such as airplanes?

Materials

- pictures of various cars and trucks
- paper
- stop watches or watches
- toy vehicles
- cardboard
- construction paper
- ticket board

Procedure

Part 1: Review with students the term **drag** from Activity 18: My Parachute, My Investigations. Have students look at a variety of pictures of cars and trucks. Have them assess the design of the vehicles to see which ones would produce more drag. Show examples of vehicles with spoilers and wind deflectors that help to reduce drag. Discuss with students the importance of reducing drag on vehicles (fuel efficiency, the reduction in the amount of fossil fuel being used). Have students design their own vehicles that would illustrate a reduction in drag.

Part 2: Students could use construction paper, cardboard, or ticket board and tape it to the front of their vehicle. They could time it to see how long it took to go down a ramp. They could do the test again without the construction paper or ticket board in the front and see if there is a difference. Discussions around how the paper increased drag on the vehicle could take place.

Part 3: Have students drop a piece of paper from a measured height. Have them time how long it took to fall to the floor and illustrate the path it took. Have the students crumple the paper up and drop it from the same height and compare the amount of time it took to fall and the path it took. Discussions on gravity and drag could take place in relation to the speed at which paper fell.

Activity 19: Reducing Drag, My Investigations

Illustration of my vehicle designed to reduce drag:

	Time in Seconds	Illustration of the Path It Travelled
Time it took the paper to fall		
Time it took the crumbled sheet of paper to fall		

What caused the reduction in the drag on the paper?

What happened to the speed at which a vehicle travelled with a cardboard/ticket board shield in front of it compared to without the shield?

Activity 20: My Flying Device

Outcome

Students will be expected to

- demonstrate methods for altering drag in flying devices and describe and show improvements in design (206-6, 301-18)

Assessment

- Students are able to assess how the type of material a flying device is made of has an impact on drag.
- Students are able to alter the amount of drag by changing the design of their flying device.

Questions

- What types of materials can be used to make an airplane?
- How does the type of paper used change the performance and affect the amount of drag on an airplane?
- How does the shape of an airplane increase or decrease the amount of drag on it?

Materials

- paper of various thicknesses
- books on making paper airplanes

Procedure

Part 1: Have students design and make paper airplanes. Have them test them to see how far they will travel. Have students change the shape and what the planes are made of to see if changing these variables has an impact on the amount of drag.

Part 2: *The Challenge:* Have students design airplanes that test the amount of time they stay airborne, how accurate they are (being able to hit a target), and the types of flips, rolls, turns, and/or loops they can do. Have students discuss the properties of the various airplanes that they made.

Activity 21: Hot Air Balloon

Outcome

Students will be expected to

- plan and perform a fair test demonstrating the characteristics that influence lift on objects in flight (204-7, 301-17, 303-32)

Assessment

- Students are able to create a model of a hot air balloon.
- Students are able to explain how the change in air temperature helps a balloon to lift off of the ground.

Question

- What causes a hot air balloon to lift off of the ground?

Materials

- glue
- tissue paper
- plastic bags
- string
- paper
- construction paper
- hair dryer(s)

Procedure

This learning experience may be done as either a teacher demonstration or a student-directed activity. The following are a few examples of the types of investigations that could take place.

Using a garbage bag, blow hot/warm air into it using a hair dryer. Have students discuss what they observed.

Tie a paper basket to a plastic bag and blow hot/warm air into it using a hair dryer. Have students discuss what they observed.

Have students make their own hot air balloons using tissue paper. Have students cut out eight pieces of the template (see below) to make their hot air balloons. Students should carefully glue the pieces together leaving the bottom open. Fill the balloon with hot/warm air using a hair dryer. Students should discuss what they observed.

In language arts, students could do a research project on hot air balloons and their history.

Teacher's Note: Hot or warm air is lighter than the surrounding cooler air, which causes the balloon to lift off of the ground. Also, with the hair dryer, the force of the blowing warm air causes the balloon to rise.

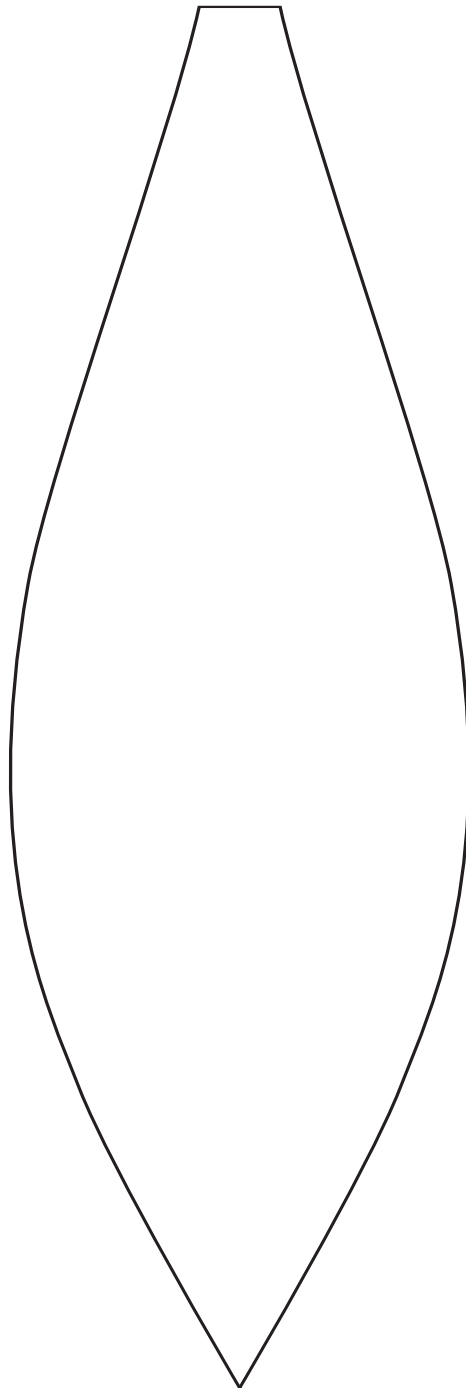

Activity 22: Gliders and Lift

Outcome

Students will be expected to

- plan and perform a fair test demonstrating the characteristics that influence lift on objects in flight (204-7, 301-17, 303-32)

Assessment

- Students are able to produce a glider that glides through the air.
- Students are able to demonstrate and explain the meaning of lift.
- Students are able to explain how the shape and length of the wings affect the distance the glider travels.

Questions

- What is meant by the term **lift**?
- How does the shape and length of a wing affect the distance a glider will travel?
- How does lift affect the ability for a glider to fly and glide?

Materials

- ticket board
- construction paper
- plastic straws
- modelling clay
- glue
- tape
- scissors
- pictures of gliders
- reference materials on gliders and flight

Procedure

Discuss with students the term **lift** and what it means in relation to flying devices.

Discuss with students what they know about gliders. Share with students pictures and/or illustrations of various types of gliders.

Provide students with materials to build a glider and have them construct one. Have students compare the wingspan of the glider to the distance it travels. Have them try different wing lengths or spans and various lengths of the glider. On the left is an example of a glider made out of ticket board and straws. A straw is put in between the fold of the front wing to make it slightly humped. A piece of modelling clay is put on the front of the straw to act as a weight.

Discuss with the students how lift helps to make the glider fly.

Teacher's Note: Lift is the force created by the shape of the wing that lifts the plane/glider upward.

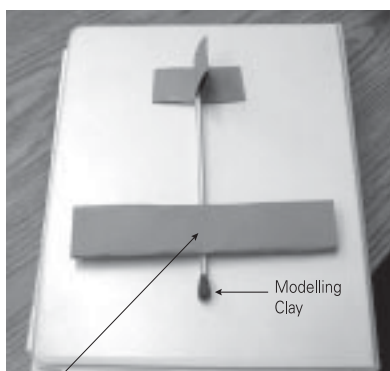

Straw glued inside the wing here, to give it a slight hump.

Activity 22: Gliders and Lift, My Investigations

Diagram of my glider including the length of the wingspan and the body of the glider:

List of materials used:

Diagram of my second glider including the length of the wingspan and the body of the glider:

List of materials used:

	Distance Travelled on First Try	Distance Travelled on Second Try
Glider 1		
Glider 2		

Describe the distance the gliders travelled in relation to the length of the wingspan and/or body length:

Activity 23: Birds and Insects That Fly

Outcome

Students will be expected to

- identify characteristics and adaptations from living things that have led to flight designs (104-3, 106-3, 300-21)

Assessment

- Students are able to illustrate a bird's wingspan.
- Students are able to explain how the shape of a bird's wing gives it lift.
- Students are able to demonstrate an understanding of how insects fly.

Questions

- How does the shape of the wing of a bird or insect help it to fly?
- What enables a bird or insect to fly?

Materials

- resources related to the flight of birds and/or insects (books, computers with Internet access)

Procedure

Have students share their knowledge of birds and insects in relation to flight. From this knowledge, develop questions that students will need to investigate in relation to how birds and insects fly. Students should be given the opportunity to share their findings with the rest of the class.

Activity 24: My Kite

Outcome

Students will be expected to

- plan and perform a fair test demonstrating the characteristics that influence lift on objects in flight (204-7, 301-17, 303-32)

Assessment

- Students are able to design a kite and explain how it should fly.
- Students are able to discuss and record problems they encountered in designing their kites and how they were able to solve them.

Questions

- What materials are needed to build a kite?
- How are kites able to stay aloft?

Materials

- thin dowels
- plastic
- string
- tape
- brown kraft paper
- materials as determined by the kite the students design
- commercially purchased kite
- computers with Internet access
- books on making kites

Procedure

Ask students if they have ever flown a kite. Discuss with them their experiences and what their kites were made of. Discussions should take place regarding how lift comes into play in helping the kite stay in the air. Students could be shown a commercially purchased kite. Have students make a list of materials they will need to build their kite.

Option 1: Provide materials for groups of students to build a kite that you as a teacher have researched and tested for success in flying.

Option 2: Have students carry out research on various types of kites and how they are constructed. From their research, have them decide which type of kite they are going to build. The school could provide the materials, or students could be asked to provide the materials they need.

Teacher's Note: Caution should be taken when flying the kites. Be aware of any electrical wires or trees.

Activity 24: My Kite, My Investigations

Materials needed to build the kite:

Diagram of the kite to be made:

Problems that were encountered, how they were resolved, and design changes:

Final diagram of the kite:

Activity 25: Lift

Outcome

Students will be expected to

- identify and collect information using models that involve lift (205-5, 303-33)

Assessment

- Students are able to demonstrate a basic understanding of lift.
- Students are able to demonstrate examples of Bernoulli's principle.

Questions

- What is meant by lift?
- How does lift support the growth of modern aviation?

Materials

- sheets of paper
- reference books
- computers with Internet access

Procedure

Part 1: Give each student a strip of paper. Have students blow air across the strip of paper. Have them share what they observed with the class.

Explanation: The air pressure was lowered as the air above the strip of paper moved faster than the air below. With the air pressure being lower on the top than on the bottom, this created lift, which caused the paper to rise.

Part 2: Have students research lift and relate it to flying devices such as airplanes and gliders. During their research, students may find other activities to try that will illustrate this principle.

Activity 26: Aerodynamic Research

Outcome

Students will be expected to

- identify characteristics and adaptations from living things that have led to flight designs (104-3, 106-3, 300-21)

Assessment

- Through research, students are able to gather relevant data and information relating to aerodynamic design.

Question

- How does the use of wind tunnels, flight simulators, and computers help in designing airplanes and wings of airplanes?

Materials

- reference books
- computers with Internet access

Procedure

Have students share their knowledge of the changes in design of airplanes over the years. Ask students how these design changes may have occurred. From these discussions, have students carry out research on wind tunnels, flight simulators, and computers in the development of airplanes and wing designs. Students should share the information they gathered with the class. Presentations could be in the form of a PowerPoint presentation, models of design changes, written reports, and Bristol board displays.

Activity 27: Propulsion and Flying

Outcome

Students will be expected to

- describe and demonstrate the means of propulsion for flying devices, using a variety of sources (303-34)

Assessment

- Students are able to demonstrate the concept of propulsion.
- Students are able to explain and describe the meaning of the term **propulsion** as it relates to flying devices.

Questions

- What does the term **propulsion** mean?
- How does propulsion help a device to fly?

Materials

- balloons (long)
- string
- tape
- paper clips
- measuring tapes and/or metre sticks
- stop watch or watch with second hand
- straws

Procedure

Part 1: Discuss with students what they think the term **propulsion** means. Put their ideas on the board. From the discussions, determine the relationship of propulsion to that of a flying device.

Part 2: Divide students into groups. Give each group string, tape, a straw, a balloon, and a metre stick. Have students run the string horizontally between two chairs (3–5 metres). Have them blow up the balloon and tape it to the straw. Students should then let go of the end of the balloon to see how far it travels.

Part 3: Have students stretch the string vertically and follow the same procedure as in step 2. Have them measure how fast it goes. Have the students compare the distance travelled horizontally to the distance travelled vertically. Discuss with students what might have caused the difference.

Activity 28: Aircraft versus Spacecraft

Outcome

Students will be expected to

- describe examples of technological design between aircraft and spacecraft and their influence on our lives (105-3, 107-9, 300-22)

Assessment

- Students are able to explain the difference between aircraft and spacecraft.

Questions

- What is the difference between a spacecraft and an aircraft?
- How does the different design justify the difference between a spacecraft and an aircraft?

Materials

- reference books
- computer with Internet access
- models of spacecrafts and airplanes
- materials to make space and/or aircraft

Procedure

Through research, students will have the opportunity to see what are the differences in design impact between a spacecraft and an aircraft. Seeing models of various types of spacecraft and aircraft would help students to have a visual understanding of the difference.

Students could be given the opportunity to build their own models to represent spacecraft or aircraft.

Activity 29: Airplanes and Spacecraft, Now and Then

Outcome

Students will be expected to

- describe examples of technological design between aircraft and spacecraft and their influence on our lives (105-3, 107-9, 300-22)

Assessment

- Students are able to carry out research through the use of non-fiction text and the use of the Internet.
- Students are able to distinguish the change in aircraft and spacecraft over the years.
- Students are able to explain and/or demonstrate how changes in space travel have affected their lives.

Questions

- How has the airplane changed in its design performances and use over time?
- How have the changes in air travel affected the work and lives of others?

Materials

- non-fiction texts
- encyclopedias
- computer with Internet access

Procedure

Students should be given the option to choose which type of craft they would like to research. They should map out what they want to learn in regards to the changes in design of the craft and the impact they have had on the lives of people. Students could be given a variety of ways to present their research to the class (PowerPoint, illustration, or poster display).

Appendix G: Activities for Earth and Space Science: Space

Activity 30: Our Moving Earth

Outcome

Students will be expected to

- demonstrate how Earth's rotation causes the day and night cycle and how Earth's revolution causes the yearly cycle of seasons (301-19)

Assessment

- Students, in pairs, are able to demonstrate a method of their choice to a classmate that shows how Earth spins around on its axis, completing one rotation marking the cycle of day and night.

Question

- Does the sun rotate around Earth or does Earth rotate around the sun?

Materials

- sticks found outside (if you have several metre sticks, these can be used)
- stopwatch
- sunny patch of ground
- masking tape
- an object that can be used as a marker—rocks, two-sided counters
- globe
- silhouette made with black construction paper taped in two places on the globe, Canada and Asia
- lamp or flashlight

Procedure

Using a metre or other long stick, stand it up in the ground. This will make it perpendicular to the ground. Use a two-sided counter (or rock) as a marker and place it at the tip of the stick's shadow. Ask students, in groups, to mark with the masking tape where they predict the shadow will be after 10 minutes. When 10 minutes are up, notice the shadow's actual position and check it against the predictions. Was the distance the shadow moved longer or shorter than your prediction? Was this surprising? Have students mark another prediction and time another 10 minutes before returning to the classroom to extend this learning experience.

Return to the classroom. Gather students around a globe. Have two small cutouts of a person or animal ready and ask a student to tape one to a place in Atlantic Canada and one to a place in Southeast Asia. Standing about two metres from the globe, turn out the lights and ask a student to point a flashlight toward one of the cutout figures. Have another student slowly rotate the globe to the right until a complete rotation has occurred. Repeat this several times, asking students the first time to simply observe the amount of light that is projected on each cutout figure as the globe rotates slowly. The second time, ask students to decide whether the sun rotates around Earth causing day or night, or Earth's rotation causes day or night.

Send students back to work in pairs to create a simple model, song, diagram, or dramatization using their bodies in some way to demonstrate how Earth's rotation causes the day and night cycle. This part of the learning experience may take several class periods.

Math Connection

Language to use with students: **rotation, perpendicular, vertical, horizontal**

Questions to ask students:

1. What can you tell me about a plane of symmetry? (6E7)
2. Can you tell me a three-dimensional shape that has at least one plane of symmetry? (6E7)
3. Do you think Earth has a plane of symmetry?
4. If you thought Earth did have a plane of symmetry, what did you assume?
5. In this activity, what is the size of the angle where the stick touches the ground?
6. The symbol for perpendicular is \perp . Do you think this symbol is appropriate? Explain using this activity.

Answers for teachers:

1. A plane of symmetry bisects a three-dimensional shape so that all points in one half are mirror images of the corresponding points on the other half.
2. A cube, rectangular pyramid, etc.
3. No
4. They assumed that the surface of Earth was smooth. That might be because they have seen only smooth models.
5. Student answers
6. Student answers

Activity 31: Changing Seasons

Outcome

Students will be expected to

- demonstrate how Earth's rotation causes the day and night cycle and how Earth's revolution causes the yearly cycle of seasons (301-19)

Assessment

- Students are able to demonstrate an understanding of what causes changes in seasons.

Question

- How does the tilt of Earth's axis of rotation and its orbit around the sun cause changes in the seasons?

Materials

- flashlight(s)
- paper
- lamp(s)
- globe(s)
- coloured tape
- pieces of paper with the seasons on them
- toothpick(s)
- modelling clay

Procedure

This activity could be part of a centred approach to teaching the concepts in this unit.

Part 1: Have the students shine a flashlight on a piece of paper that is held at 90 degrees to the flashlight and draw a circle around it. Have them discuss the strength of the rays of light coming from the flashlight. Now have them change the angle of the flashlight and have them draw the rays of light on the paper. Have them discuss the concentration of light at this angle. Have them compare the two. Ask them which ray of light was more concentrated. From these discussions a comparison of the sun's rays to this demonstration could be carried out. In the summer, the rays of light are more concentrated and thus provide more heat than in the winter months.

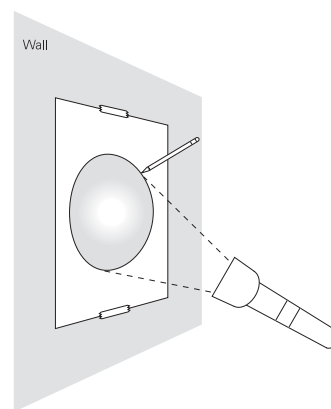

Extension: Draw or tape a circular representation of Earth on the floor. Put pieces of paper down to represent the four seasons. Use a piece of modelling clay to mount the toothpick where they live on the globe. Place a lamp in the centre part of the orbital path of the Earth to represent the sun (see diagram). Have the students discuss the amount of light on the different parts of the globe. Make sure that as they are moving their globe around the sun the axis and direction of the globe stay the same. Have the students stop at several places and turn the globe on its axis so that the toothpick faces the light. Have them discuss the changes in the shadow of the toothpick. Have them note the concentration of light on the place where they live. From this, discuss the concentration of the sun's rays and how in the summer they are more concentrated than in the winter. They can then try this again using a different part of the world and discuss the seasons where they live in comparison to the seasons in other countries or continents in the world.

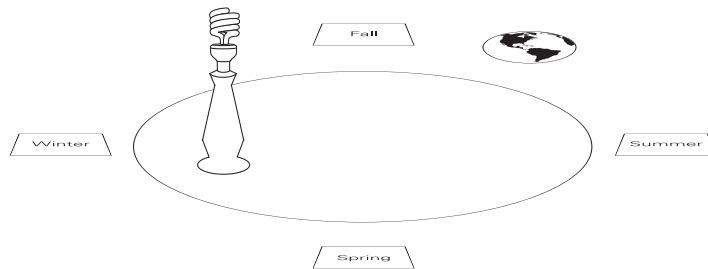

Math Connection

Language to model and use with students:

Clockwise, counter-clockwise: as when students are moving the globe: Did you move the globe in a clockwise or counter-clockwise direction?

Vertical: Place the paper vertically in front of the flashlight.

Horizontal: acute angle. Angle the flashlight upward approximately 30 degrees from the horizontal.

Discuss the meaning of acute angle.

Also in this activity, you could keep the flashlight horizontal, move it closer to and farther from the paper and discuss the concepts of enlarging and reducing and the idea of similarity (6E6). With this discussion, use the terms **enlargement** and **reduction**.

Activity 32: Day and Night

Outcome

Students will be expected to

- demonstrate how Earth's rotation causes the day and night cycle and how Earth's revolution causes the yearly cycle of seasons (301-19)

Assessment

- Students are able to demonstrate an understanding of what causes day and night.

Question

- What causes us to have day and night?

Materials

- globe(s)
- toothpick(s)
- modelling clay
- compass(es)
- high-powered flashlight

Procedure

This activity could be part of a centred approach to teaching the concepts in this unit.

Part 1: Have the students take a globe(s) outside into an area where there are no other shadows from other objects appearing on the globe. Using a compass, have the North Pole on the globe point to the north. Use a piece of modelling clay to mount the toothpick where you live on the globe. Now rotate the globe so that the clay and toothpick are on the top. Have students talk about the shadow produced by the toothpick on the globe compared to those on the ground. Have them look at the rest of the globe and decide which areas are in darkness and which ones are receiving sunlight.

After the students have completed this, have them rotate the globe to the east and look again at Earth and record what they see.

Part 2: Using six students, have five of them hold hands and form a circle. The sixth student is to shine the flashlight toward the centre of the circle. Have the lights dimmed in the room. The students forming the circle are to start walking in a circle (which represents Earth rotating on its axis) without holding hands. The part of the circle that is illuminated by the light represents daytime while the part that is in the darkness represents the night.

Math Connection

Language to model and use with students:

Rotation: Rotate the globe to the east.

Similar figures, enlargement, reduction, dilation, corresponding angles, corresponding sides (6E6)

- What does the word **similar** mean? Give an example of two things that are similar.
- Identify the corresponding angles. What is true about corresponding angles? (In similar figures, corresponding angles are congruent.)

Activity 33: Moon Watching

Outcome

Students will be expected to

- observe and explain how the relative positions of Earth, the moon, and the sun are responsible for the moon phases, eclipses, and tides (301-20)

Assessment

- Students are able to observe and record the phases of the moon over a one-month period.

Questions

- Does the moon look the same every night?
- What kind of changes did you observe?
- Did these phases reoccur every month?

Materials

- none

Procedure

This learning experience should take place prior to the unit of study on space.

Assign students different months to “moon watch” from the beginning of the year. Preceding the anticipated time you will be teaching the unit on space, ask students to watch the night sky over a one-month period and record the shape of the moon each night. Encourage students to record their observations using a graphic organizer of their own choice. Some possibilities may include a reproduction of a calendar, dated entries in a logbook, or a table that is generated by the student (see example below).

Put the completed assignments in a safe place so that they can be used and referred to for the learning experience that follows in Activity 34: Phases of the Moon.

Date	Illustration of the Moon	Type of Moon
March 2, 2007		waxing crescent

Activity 34: Phases of the Moon

Outcome

Students will be expected to

- demonstrate how Earth's rotation causes the day and night cycle and how Earth's revolution causes the yearly cycle of seasons (301-19)

Assessment

- Students are able to demonstrate an understanding of the phases of the moon.

Questions

- How can we demonstrate the various phases of the moon?
- What causes the various phases of the moon?

Materials

- lamp
- Styrofoam ball (painted black) or a soft small coloured ball
- pencil or bamboo skewer
- modelling clay (white and black)
- lamp

Procedure

This activity could be part of a centred approach to teaching the concepts in this unit.

Have students mark an X on the ball. Have them push the pencil or bamboo skewer into the ball. With the X facing the student, it represents the face of the moon they would see from Earth. After the room has been darkened and the lamp turned on, have students hold the "moon" at an arm's length. As the students turn counter-clockwise (staying in the same spot), make sure the X stays facing them. Have them record the various stages of the moon on a chart (see chart example below).

Phases of the Moon

moon phase at 45 degrees	
moon phase at 90 degrees	
moon phase at 180 degrees	
moon phase at 270 degrees	
moon phase at 360 degrees	

Teacher Note: The following information will help both teachers and students understand the phases of the moon.

Full Moon: When the moon is full, it rises at sunset and is visible all night long. At the end of the night, the full moon sets just as the sun rises. None of the moon's other phases have this characteristic. It happens because the moon is directly opposite the sun in the sky when the moon is full. During this phase the moon's entire illuminated half faces toward us.

New Moon: This occurs when the illuminated half faces away from us. This happens when the moon is between the sun and Earth.

Waxing and Waning Moons: When the moon moves from the new moon to a full moon, the illuminated portion becomes larger and is said to be waxing. As the moon moves from full moon to new moon its illuminated portion gets smaller or is said to be waning.

The same side of the moon always faces Earth. It is the shadow on the moon that moves as the phases change.

Phases of the Moon



Gibbous Phases: A gibbous moon is between a full moon and a half moon or between a half moon and a full moon.

Visual Arts: Have students represent the eight phases of the moon using white and black modelling clay. Have them label each phase. Students may want to make a scene out of modelling clay and have one phase of the moon in the sky.

Math Connection

Language to model and use with students: **rotation, quarter turn, half turn, three-quarter turn** (Mathematics 5, E10)

1. A rotation of Earth on its axis through a quarter turn corresponds to what phase of the moon?
2. Repeat #1 for half turn and three-quarter turn.
3. The above questions could go the other way, where you give students the moon phase and ask for the turn.

4. Explain how 1:4 and 90:360 represent the same relationship in this activity. (Mathematics 6, A4; Please read this outcome carefully because many things suggested in it can come out in this activity.)
5. State two more pairs of equivalent ratios and explain why they are equal.
6. You could also just give a ratio such as 1:4 and ask students for an equivalent ratio and why.
7. Explore with students the multiplicative relationships in equivalent ratios. For example, multiplying both parts of 1:4 by 90 yields 90:360.
8. Can you express a quarter turn as a fraction? Can you express a half turn as a fraction? Can you express a three-quarter turn as a fraction?
9. What are the decimal equivalents for the fractions stated in # 8? (Mathematics 6, A9)
10. Place these decimal numbers where you think they belong on the number line. Explain your thinking.



Activity 34: Phases of the Moon, My Investigations

Name: _____ Date: _____

Phases of the Moon

moon phase at 45 degrees	
moon phase at 90 degrees	
moon phase at 180 degrees	
moon phase at 270 degrees	
moon phase at 360 degrees	

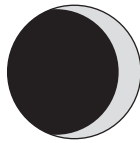
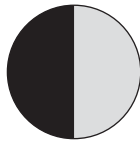
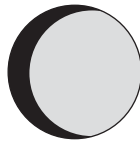
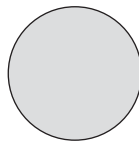
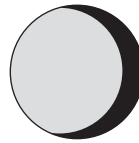
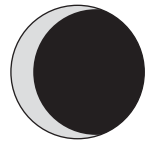
New
MoonWaxing
CrescentFirst
QuarterWaxing
GibbousFull
MoonWaning
GibbousLast
QuarterWaning
Crescent

Activity 35: Lunar Eclipse

Outcome

Students will be expected to

- observe and explain how the relative positions of Earth, the moon, and the sun are responsible for the moon phases, eclipses, and tides (301-20)

Assessment

- Students are able to demonstrate an understanding of what a lunar eclipse is.

Questions

- What is a lunar eclipse?
- What causes a lunar eclipse?
- How might one create a lunar eclipse to demonstrate how it is formed?

Materials

- flashlights
- tennis balls
- inflatable Earths or beach balls
- basketballs

Procedure

This activity could be part of a centred approach to teaching the concepts in this unit.

Have students hold a flashlight (sun) behind the beach ball (Earth) and the tennis ball (moon). See illustration below.

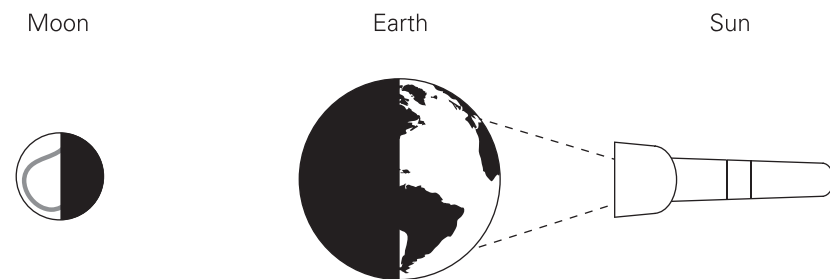

Teacher's Note: A lunar eclipse occurs when Earth blocks the sun's light from reaching the moon. When an eclipse of the moon takes place, everyone on the night side of Earth can see it. An eclipse of the moon (or lunar eclipse) can occur only at full moon.

Activity 36: Solar Eclipse

Outcome

Students will be expected to

- observe and explain how the relative positions of Earth, the moon, and the sun are responsible for the moon phases, eclipses, and tides (301-20)

Assessment

- Students are able to demonstrate an understanding of what a solar eclipse is.

Questions

- What is a solar eclipse?
- What causes a solar eclipse?
- How might one create a solar eclipse to demonstrate how it is formed?

Materials

- ping-pong balls or small balls of that size

Procedure

This activity could be part of a centred approach to teaching the concepts in this unit.

Have each student hold a ping-pong ball at arm's length. Now have them find something in the room they want to block from view. Have them squint with one eye and move the ping-pong ball toward them until the object has been completely blocked out. With the ping-pong ball representing the moon and the object representing the sun, the students, on Earth, would be in the shadow of the moon. None of the sun's rays would reach the students. Students may want to try this with another object.

Teacher's Note: An eclipse of the sun (or solar eclipse) can occur only at new moon when the moon passes between Earth and the sun. The total phase of a solar eclipse is very brief. It rarely lasts more than several minutes.

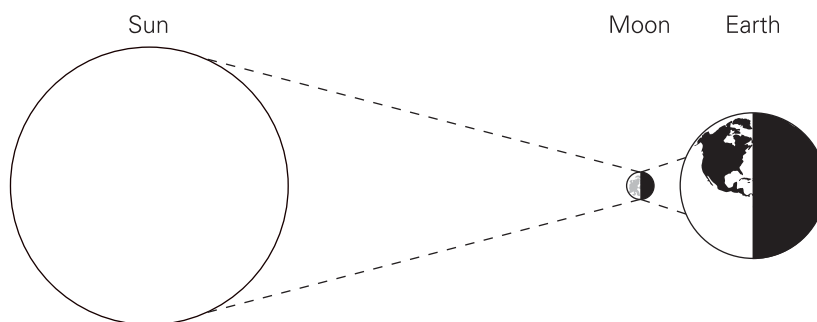

Not drawn to scale.

Activity 37: Planets in Our Solar System

Outcome

Students will be expected to

- gather information, describe, and display the physical characteristics of components of the solar system (205-2, 300-23, 104-8)

Assessment

- Students are able to show the relative position of the planets in our solar system.

Questions

- What are the planets in our solar system?
- How are they aligned in the solar system?

Materials

- inflatable models of the planets located in our solar system and/or models of planets (purchased or made)
- model of the sun

Procedure

This activity could be part of a centred approach to teaching the concepts in this unit.

Have students use models of the planets to show their distance from the sun. From their display, help students realize that the planets in our solar system revolve around the sun. Have them discuss the importance of “scale” when representing the size of planets and their distance from the sun. Students should record the position of their planets through illustrations in their science journals.

Using the Internet, find information about the planets’ average distances from our sun and the diameter of the equators.

Teacher’s Note: 150 000 000 km = 1 AU (astronomical unit). On Thursday, August 24, 2006, the International Astronomical Union (IAU) stripped Pluto of its planetary status, which it had held since its discovery in 1930. Pluto, which was named for the god of the underworld, has had its status changed to that of a new category of “dwarf planets.” Our solar system has been downsized from nine planets to eight. The IAU defined planets and other bodies in our solar system as follows:

- Planet:* a celestial body that is in orbit around the sun, has sufficient mass for its self-gravity to overcome rigid body forces so that it assumes a nearly round shape, and has cleared the neighbourhood around its orbit.

- *Dwarf Planet*: a celestial body that is in an orbit around the sun, has sufficient mass for its self-gravity to overcome rigid body forces so that it assumes a nearly round shape, has not cleared the neighbourhood around its orbit, and is not a satellite.
- All other objects (except satellites) orbiting the sun will be referred to as small solar system bodies.

Math Connection

1. When students are stating the average distance from the sun (AU), they should properly read the number.

0.39 is read thirty-nine hundredths, not “point” or “decimal” thirty-nine.

5.2 is read five and two tenths

2. When students record decimal numbers between zero and one, remember to include the zero before the decimal.

0.39 is the proper form, .39 is not.

3. The diameter at the equator, 4 879, is read four thousand eight hundred seventy-nine. It is not correct to say the word “and” when stating this number.

*Questions to ask students
(using various resources)*

1. Which planet is approximately 10 times bigger than Mercury?
2. Approximately how many times bigger is the diameter of Saturn than the diameter of Mars? Explain your thinking.
3. Use estimation strategies to determine if this ratio is less than or

greater than $\frac{1}{2}$. (Mathematics 6, B9)

A possible solution follows. This is a great activity to practise estimation. It also connects to benchmarks.

$$\frac{4879}{12104}; \text{ so } \frac{4879}{12104} \rightarrow \frac{5000}{12000} \rightarrow \frac{5}{12}$$

I know $\frac{6}{12} = \frac{1}{2}$, $\frac{5}{12}$ is less than $\frac{6}{12}$, so $\frac{5}{12}$ is less than $\frac{1}{2}$.

4. Determine if the ratio of the diameters of Mars and Earth is less than or greater than $\frac{1}{2}$. Use the estimation strategy shown above to help explain your answer.

5. Determine whether the ratio of the diameters of Mercury to Earth is less than or greater than $\frac{1}{10}$. Use the estimation strategy shown above to help explain your answer.
6. Which planet is approximately 10 times the size of Mercury? Explain your thinking.
7. Which planet is 20 times the size of Mars? Explain your thinking.

Activity 38: The Solar System

Outcome

Students will be expected to

- gather information, describe, and display the physical characteristics of components of the solar system (205-2, 300-23, 104-8)

Assessment

- Students are able to complete research that enables them to focus on an aspect of the solar system that is of interest to them.
- Students are able to represent the solar system or parts of it (specific planets, asteroids, etc.) in a three-dimensional representation.

Questions

- What are the components of our solar system?
- How are planets different from moons?
- What causes asteroids, comets, and meteors?
- What is an asteroid, a comet, and a meteor?
- How are the planets in our solar system similar? How are they different?

Materials

- access to Internet and appropriate (viewed by teacher) websites to access information that describes the various planets, asteroids, meteors, moons, and comets
- a variety of non-fiction texts that support a range of readers
- videos/DVDs that support the topic
- materials to make models of various components of the solar system (clay, papier mâché, paper, stones, Styrofoam balls)

Procedure

Option 1: Discuss with students what they know about the solar system they are a part of and what it consists of. From these discussions, make a list of information the students provide and then invite them to choose a specific item to research and make a model of it. The models should be made in proportion to their actual size. Students could then put their projects together to form a model of the universe. Students should share their research with the class.

Option 2: Have students work in groups to make models of the solar system and label each part.

Option 3: As a class project, convert the classroom into the solar system. Replicas of planets, the sun, asteroids, and meteors could be hung from the ceiling, depending on your school safety guidelines. With each model, a brief description could be hung with the model.

Teacher’s Note: The following are brief descriptions of various small solar system bodies:

Asteroid: the term asteroid is Greek for “star-like” and is generally used to indicate a diverse group of small celestial bodies that drift in the solar system in orbit around the sun

Comet: a mixture of ices (both water and frozen gases) and dust that for some reason didn’t get incorporated into planets when the solar system was formed; comets located near the sun that are active are made up of

- *nucleus*—relatively solid and stable, mostly ice and gas with a small amount of dust and other solids
- *coma*—dense cloud of water, carbon dioxide, and other neutral gases
- *hydrogen cloud*—huge (millions of kilometres in diameter) but very sparse envelope of neutral hydrogen
- *dust tail*—up to ten million kilometres long, composed of smoke-sized dust particles driven off the nucleus by escaping gases, which is the most prominent part of a comet to the unaided eye
- *ion tail*—as much as several hundred million kilometres long, composed of plasma and laced with rays and streamers

Meteor or “shooting star”: the term used when a meteoroid (the smallest body in the solar system that can be observed with the eye and that may have come from debris left behind by a comet) enters Earth’s atmosphere and is heated by friction and for a few seconds streaks across the sky as a meteor with a glowing trail

Moon: an object that orbits a planet or other body larger than itself and that is not human-made.

Star: a massive, luminous ball of plasma; stars group together to form galaxies and dominate the universe (The nearest star to Earth is the sun.)

Activity 39: My Constellation

Outcomes

Students will be expected to

- identify constellations from diagrams, pictures, and/or representations of the night sky (302-13, 207-2)
- describe and compare how different societies have interpreted natural phenomena, using a variety of sources, to validate scientific knowledge (105-6, 205-8, 107-3)

Assessment

- Students are able to make and name their own constellations.
- Students are able to both orally and written tell a mythological story or legend about the constellation they made.

Question

- How does your myth or legend bring meaning to your constellation?

Materials

- black construction paper
- overhead projector
- towel rolls
- tape
- flashlights

Procedure

This learning experience is an introduction to constellations. Discussions on what students think constellations are should be carried out. In order to have them make their own myths or legends, discussions on what various constellations are and represent should be left for Activity 40: Star Light, Star Bright. Give students various options on what materials they could use to make their constellations and to project them on a wall or ceiling. From this have them create their own constellations. After they have completed them, have students write their myths or legends about them. Students should share their ideas with the class.

Activity 40: Star Light, Star Bright

Outcome

Students will be expected to

- identify constellations from diagrams, pictures, and/or representations of the night sky (302-13, 207-2)
- describe and compare how different societies have interpreted natural phenomena, using a variety of sources, to validate scientific knowledge (105-6, 205-8, 107-3)

Assessment

- Students are able to name a constellation projected through the “starscope” and talk about its defining features that would make it easy to identify in the night sky.
- Students are able to orally tell mythological stories, either generated creatively or through researching the ancient societies and retelling their myths or legends about the constellations.

Question

- How would you describe to others a way to identify the constellation you chose to represent through your “starscope,” making it easy to recognize in the night sky?

Materials

- cylindrical box or can
- compass
- sheet of black construction paper
- an elastic band
- scissors
- chalk
- flashlight
- print resources on constellations and mythology
- access to the Internet to explore information on constellations and/or mythology

Procedure

Prior to this learning experience, perhaps during English language arts time or exploration of world cultures as part of social studies, students should be provided with opportunity to gather information on the visual characteristics and mythology of constellations.

Remove both ends of the box or can. Use a compass to draw a circle on the black construction paper about 5 cm wider than the end of the box or can. Cut out the circle and place it over one end and secure the paper with an elastic band. Use chalk to draw the constellation on the cover of the paper. Use the pointed end of the compass to make a hole through each star of the constellation. Next, put a flashlight inside the starscope, turn on the flashlight, and darken the room. Point the papered end toward the ceiling until a clear image of the constellation appears.

Students will enjoy taking turns sharing their constellations. Challenge students to guess the constellations and describe what visual characteristics of the specific constellation stood out for them.

In small groups, students can orally share their own myths or legends of their constellations or retell the myths or legends that have passed down through ancient societies.

Activity 41: Moving in a Space Suit

Outcome

Students will be expected to

- describe, based on evidence, and make conclusions about how astronauts are able to meet their basic needs in space (206-5, 301-21)

Assessment

- Students are able to develop an understanding of the challenges of being in a space suit.

Questions

- How are spacesuits designed to meet the needs of astronauts?
- How have scientists designed spacesuits so that they are flexible enough for people to move their arms and legs in them?

Materials

- long balloons
- elastic bands
- access to books and/or Internet sites on spacesuits

Procedure

This activity could be part of a centred approach to teaching the concepts in this unit.

Part 1: Have students blow up a balloon and try to bend it. Have them discuss the difficulty in bending it and having the balloon stay in the bent position. Students should then discuss how they might make the balloon more flexible. As they are blowing up the second balloon have them place an elastic band around it at different intervals. Now have them try to bend it and compare its flexibility to the first balloon. Have students compare this to a spacesuit where it has to be flexible at various locations such as in the areas of the knees and elbows.

Part 2: Have students carry out research on how astronauts are able to perform their assignments in space and meet their basic needs.

Activity 42: Space Exploration around the World

Outcome

Students will be expected to

- describe and give examples of information and contributions that have led to new inventions and applications (106-3, 107-15, 206-4)

Assessment

- Students are able to assess the work of their peers and their understanding of improvements to the tools and techniques of the solar system that have led to new discoveries and scientific information about space and whether their peers have adequately described scientific and/or technical achievements in space, both recent and past, that have resulted from contributions by people around the world.

Questions

- To what extent do people from around the world in various cultures contribute to an understanding of the world of space?
- Can you think of a reason that would explain the different perspectives of world cultures towards space exploration and inquiry of space, both recent and in the past?
- What are some improvements to the tools and techniques used to investigate the solar system?

Materials

- access to Internet and appropriate (viewed by teacher) websites to access information that describes how astronauts live in space
- a variety of non-fiction texts that support a range of readers
- videos/DVDs that support the topic
- 11" × 17" paper

Procedure

This learning experience integrates English language arts specific curriculum outcomes 4.1, 4.3, 5.1, 8.2, and 10.5 to investigate improvements to the tools and techniques used to learn more about the solar system and to explore scientific and technical achievements in space. Addressing this outcome of study in Science 6 to that of the concept of interdependence of world cultures in social studies also provides students with the opportunity to explore and investigate both recent and past scientific and technical achievements that are the result of contributions by people of differing world cultures.

From time to read and view and to make notes during the research phase, students should be then provided with materials to construct a two-page spread as a possible addition into their student textbooks for science, incorporating various features of non-fiction text to display

their information. This could include photographs with captions, charts, labelled diagrams, cross-sections, illustrations, subheadings, or a glossary of key vocabulary. Students should be provided with 11" × 17" paper as the backdrop to complete their two-page spreads. Throughout the process and upon completion, in small groups or in pairs, students can exchange two-page spreads and peer assess to determine if the text features included support the reader in their understanding of the topic.

As a close to this learning experience, students should share their findings with the whole class, as different information will be discovered depending on the sources used. This could also provide an opportunity for some debate should similar information be written from varying perspectives or bias. A discussion of gender and space exploration may also emerge depending on the types of information tended to be published and who or which cultures' advances may have been left out.

Appendix H: Activities for Life Science: Diversity of Life

Activity 43: Trees All around Us

Outcome

Students will be expected to

- classify and compare the adaptations of closely related animals and plants living in their local habitat and in different parts of the world and discuss reasons for any differences (301-15, 104-5, 204-6)

Assessment

- Students are able to classify trees using several attributes.
- Students are able to identify how they classified the trees in their habitat.

Questions

- What is meant by the term **classification**?
- What attributes could be used to classify trees?
- How did our group's classification structures differ? How were they the same?

Materials

- clipboards
- digital cameras
- paper
- crayons
- books with descriptions and illustrations of various types of trees
- Activity 43: Trees All around Us, My Investigations

Procedure

Part 1: Take the students on a walk around the school area. Have them write down everything they see. In the classroom, have the students divide what they saw into two groups. Have them explain how they decided to divide their groups.

Part 2: As a class, develop a working definition and understanding of the term **classification**. Discuss the term **attribute** and what it means.

Prior to going outside to classify the trees, have each group of students discuss what type of classification strategy and attributes they will use. For example, one group may classify trees according to size, another may classify trees according to the type of leaves or needles. Have students take their classification attributes and explore the trees in a local habitat.

Part 3: Using resources or technologies, have students identify the types of trees they classified.

Activity 43: Trees All around Us, My Investigations**Classifying Trees**

Type of Tree	Classification Attributes	Number of Trees

Illustration of trees classified:

Activity 44: Plants in My Habitat

Outcome

Students will be expected to

- classify and compare the adaptations of closely related animals and plants living in their local habitat and in different parts of the world and discuss reasons for any differences (301-15, 104-5, 204-6)

Assessment

- Students are able to design classification strategies for plants in their habitat.
- Students are able to explain their classification strategies/guidelines to other students.

Questions

- How can plants be classified?
- What types of classification strategies should be used?
- What types of plants were found in the habitat?

Materials

- clipboards
- digital cameras
- reference books on plants
- hand-held magnifiers
- attribute rings or hoops

Procedure

Part 1: This learning experience will have students observing the smaller plant world. Students should review how they classified the trees in their habitat in Activity 43 and see if any of the same classification attributes could be used when looking at smaller plants. Students may decide to classify their plants by colour, size, shape, broad leaves, narrow leaves, or plant species, to name a few.

Teacher's Note: You may want to start by having students look at a large area in their habitat and then reduce the area to that of the size of a hoop or attribute ring.

Part 2: Using resources or technologies have students identify the types of plants they classified.

Activity 44: Plants in My Habitat, My Investigations

Classifying Plants

		Drawing of the Plant
Type of Plant		
Classification Attribute		
Number of Plants		
Type of Plant		
Classification Attribute		
Number of Plants		
Type of Plant		
Classification Attribute		
Number of Plants		
Type of Plant		
Classification Attribute		
Number of Plants		

How the plants were classified:

Activity 45: Animals in My Habitat

Outcome

Students will be expected to

- classify and compare the adaptations of closely related animals and plants living in their local habitat and in different parts of the world and discuss reasons for any differences (301-15, 104-5, 204-6)

Assessment

- Students are able to design classification attributes for the animals in their habitat.
- Students are able to explain how they classified the animals found in their habitat.

Questions

- How can animals be classified?
- How are you able to distinguish the animals from one another?
- What attributes did you use to classify the animals in your habitat?

Materials

- clipboards
- digital cameras
- reference books on animals that could be found in a local habitat (insects or worms)
- hand-held magnifiers
- attribute rings or hoops
- trowels

Procedure

Part 1: Discuss with the students the type of animals they might find in a local habitat. From these discussions, have students decide how they might classify the animals they find. Some examples could be animals with legs, animals with no legs, animals with wings, large animals, or small animals, to name a few. Students could start by observing animals in a large area and then reducing the size of the area to that of a hoop or attribute ring.

Teacher's Note: Students should be made aware of respecting their local habitat. Students should be careful not to injure or destroy the animals they find.

Part 2: Using resources or technologies, have students identify the types of animals they classified.

Activity 45: Animals in My Habitat, My Investigations

Classification Chart

		Drawing of the Animal
Type of Animal		
Classification Attribute		
Number of Animals		
Type of Animal		
Classification Attribute		
Number of Animals		
Type of Animal		
Classification Attribute		
Number of Animals		
Type of Animal		
Classification Attribute		
Number of Animals		

How the animals were classified:

Activity 46: Classification Systems

Outcome

Students will be expected to

- create and analyse their own chart or diagram for classifying and describe the role of a common classification system (206-1, 206-9, 300-15)

Assessment

- Students show an understanding of the term **classification**.
- Students use prior experiences to develop their own classification schemes.

Questions

- What is meant by the term **classification**?
- How would you be able to use the data from previous activities to develop your own classification scheme?

Materials

- data from previous activities in this unit

Procedure

Discuss with students the term **classification**. Develop a working definition from the responses of the students. Have the students develop a classification scheme for the data they collected in Activity 43 and 45. Have them place the living things they found into their classification scheme.

Teacher's Note: Dichotomous keys are used for classification.

Activity 47: The Animal Kingdom

Outcome

Students will be expected to

- classify animals as vertebrates or invertebrates and compare the characteristics of mammals, birds, reptiles, amphibians, and fishes (300-16, 300-17)

Assessment

- Students are able to classify animals under a variety of subgroups.
- Students develop language/vocabulary that reflects their knowledge of a variety of subgroups in the animal kingdom.

Questions

- What is meant by the term **animal kingdom**?
- What are the names of the main subgroups of the animal kingdom?

Materials

- pictures of a variety of animals
- computers with Internet access
- Kidspiration

Procedure

In this learning experience, students will be given an opportunity to learn about a variety of subgroups in the animal kingdom. The groups vertebrate and invertebrate will be explored in Activity 48: Vertebrates, Invertebrates. Pictures of a variety of animals could be displayed, and after discussions on various subgroups, students should match the animal to the subgroup.

Teacher's Note: Some subgroups to explore could be fish, amphibians, reptiles, birds, and mammals. The program Kidspiration could be used for students to make classification trees with words and pictures.

Activity 48: Vertebrates, Invertebrates

Outcome

Students will be expected to

- classify animals as vertebrates or invertebrates and compare the characteristics of mammals, birds, reptiles, amphibians, and fishes (300-16, 300-17)

Assessment

- Given a variety of animals, students are able to classify them as vertebrates or invertebrates.
- Students are able to look at animals in their local habitat and classify them as either vertebrates or invertebrates.

Questions

- What is meant by the term **vertebrate**?
- What is meant by the term **invertebrate**?
- How can one tell if an animal is classified as a vertebrate or an invertebrate?

Materials

- pictures of a variety of animals
- computers with Internet access
- Kidspiration
- Activity 48: Vertebrates, Invertebrates, My Investigations

Procedure

Part 1: Have a variety of pictures of animals that are vertebrates and invertebrates. On the back of the vertebrate cards put an A and on the back of the invertebrate cards put a B. Have at least two of each animal. Give each student a card with an animal on it. Have them find the other person(s) with the same animal card by imitating the sound that the animal makes, how it moves, etc. Once the students find their partners, have them look at the back of the cards and divide into the two groups. Have them discuss the characteristics of their animal.

Part 2: After students have discussed the similarities of their animals, discuss with them the terms **vertebrate** and **invertebrate**. Develop working definitions for each term and post them in the classroom. In Activity 47: The Animal Kingdom, students developed an understanding of the various subgroups of the animal kingdom. Give students a variety of pictures of animals and have them sort them into vertebrates or invertebrates. Have students share their groupings with the class and explain how they decided on their groupings.

Students could refer to their data from Activity 45: Animals in My Habitat, My Investigations, and classify them as vertebrates and not vertebrates (invertebrates). This classification is a dichotomous key that classifies items as “this” and “not this.”

Activity 48: Vertebrates, Invertebrates, My Investigations**Sorting Animals**

Animal	Vertebrate	Not Vertebrate (Invertebrate)

Were there any animals that you found difficult to classify? If so, which ones?

How does this classification of animals help us to better understand them and where they live?

Activity 49: Arthropods

Outcome

Students will be expected to

- classify common arthropods using a variety of sources (205-8, 300-18)

Assessment

- Given a variety of animals, students are able to identify them as arthropods or other.
- Students have shown an understanding of the term **arthropod**.

Questions

- What does the term **arthropod** mean?
- What types of arthropods live in the habitat around your school or home?
- How does classifying animals as arthropods or other help in identifying animals?

Materials

- clipboards
- hand-held magnifiers
- pictures of arthropods
- computers with Internet access
- Kidspiration
- trowels
- Activity 49: Arthropods, My Investigations

Procedure

Discuss with students the term **arthropod**. Develop a working definition and post this in the classroom. Divide arthropods into various subgroups such as

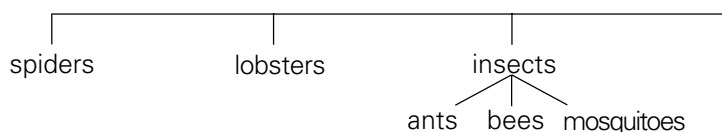

Part 1: Have students revisit the habitat around the school and make a list of arthropods that they find. Have them write down the characteristics of each one. Have students observe and discuss the differences between ants and spiders.

Part 2: Provide students with pictures of a variety of arthropods and have them discuss their similarities and differences.

Part 3: Have students classify arthropods as vertebrates or other.

Students could illustrate their classification scheme using the software program Kidspiration.

Activity 49: Arthropods, My Investigations

Arthropods in Our Habitat

Name of Arthropod	Description	Illustration

How were the arthropods you found similar?

What characteristics of the arthropods made them different from one another?

Which type of arthropod did you find the most of?

Activity 50: Models of Vertebrates or Invertebrates

Outcomes

Students will be expected to

- classify animals as vertebrates or invertebrates and compare the characteristics of mammals, birds, reptiles, amphibians, and fishes (300-16, 300-17)
- classify common arthropods using a variety of sources (205-8, 300-18)

Assessment

- Students are able to design and build a model of an animal that is a vertebrate or invertebrate.

Question

- What materials will be needed to make a model of my animal?

Materials

- as required by students to make their model (clay, plaster of Paris, paint, paper towel rolls, Bristol or ticket board, tissue paper, paint brushes)
- attribute rings

Procedure

Option 1: Students have developed an understanding of the terms **vertebrate** and **invertebrate**. Have the students make models of animals of their choice. You may wish to limit the choices to animals in their habitat. Have them label the various parts and indicate if it is an animal with a backbone or not and what subgroup it belongs to.

Option 2: Students could be given a picture of the skeletal system of an animal. Give each student a 15 cm × 18 cm piece of black Bristol board and white clay. Have them make the skeletal system using the clay.

Option 3: Students should sort animals according to their attributes.

Activity 51: Magnification

Outcome

Students will be expected to

- identify and use appropriate tools to examine micro-organisms and describe how they meet their basic needs (204-8, 300-19, 302-12)

Assessment

- Students show their ability to use a microscope.
- Students' use of the microscope enables them to draw and explain the details of living things that they could not see with the naked eye.

Questions

- How does the use of microscopes help us see living things in greater detail?
- Where are microscopes used?

Materials

- microscopes
- microscope slides
- Intel microscopes
- tweezers
- Activity 51: Magnification, My Investigations

Procedure

Part 1: Review with students the parts of a microscope and how it is used. Have students find a living thing (blade of grass, weed, or leaf) and view it using the microscope. Have them describe and illustrate what they see by using the microscope. Have them compare what they viewed using the microscope compared to viewing it with the naked eye. Discuss with students where microscopes are used and their importance.

Students may wish to take particles of dust and see if there are any living things in them. Students should wash their hands after handling the dust particles or use tweezers.

Part 2: Using an Intel microscope, have students take a picture of a living thing. Have the picture saved and inserted into a word processing program. Students could then write a poem or story about their picture.

Activity 51: Magnification, My Investigations

Illustration and description using the naked eye:

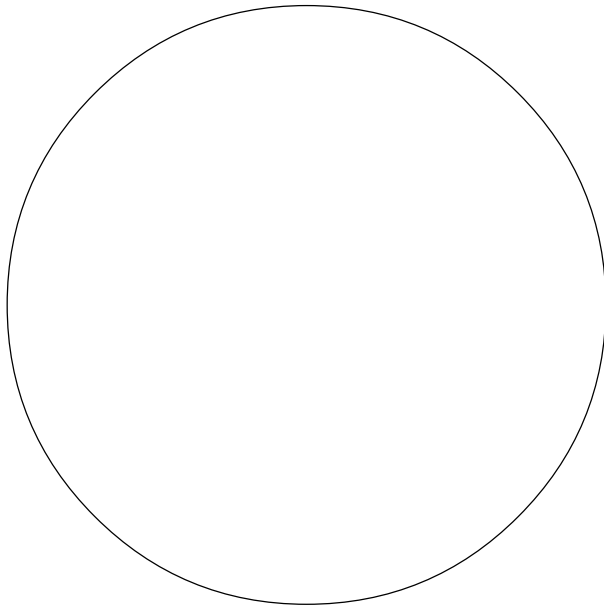
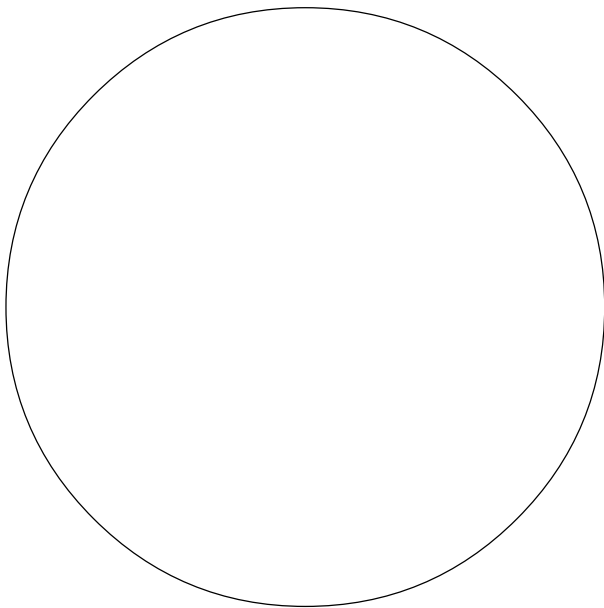

Illustration and description using a microscope:



What differences did you notice in viewing a living thing with a microscope compared to viewing it with the naked eye?

Activity 52: Micro-organisms

Outcomes

Students will be expected to

- identify and use appropriate tools to examine micro-organisms and describe how they meet their basic needs (204-8, 300-19, 302-12)
- provide examples of how science and technology have been used in identifying and controlling micro-organisms by different people around the world (107-3, 107-6)

Assessment

- Through observation and discussions, students will demonstrate and explain how micro-organisms meet their basic needs.
- Students are able to draw what they observe using a microscope.

Questions

- What are micro-organisms?
- What do micro-organisms need to survive?
- How do micro-organisms meet their basic needs?

Materials

- microscopes
- prepared microscope slides
- Intel microscope
- background information on micro-organisms
- computers with Internet access

Procedure

Part 1: Students should be provided the opportunity to observe micro-organisms using a microscope and prepared slides. Discussions should include what micro-organisms are and what they need to survive. Students should draw the micro-organisms they observe in their science journals. Resources should be made available for students to gather information on the basic needs of micro-organisms and where they can be found.

Part 2: In groups, have students look up various types of micro-organisms on the Internet under headings such as

- bacteria
- effective micro-organisms
- micro-organisms in water
- harmful micro-organisms
- living soil and micro-organisms
- types of micro-organisms

Invite them to report their findings to the class.

Activity 53: Micro-organisms— Helpful or Harmful

Outcome

Students will be expected to

- provide examples of how science and technology have been used in identifying and controlling micro-organisms by different people around the world (107-3, 107-6)

Assessment

- Students show an understanding of the importance of micro-organisms through research and discussion.
- Students are able to explain how some micro-organisms are helpful and some are harmful.

Questions

- How has the use of micro-organisms been developed?
- How have humans learned to control harmful micro-organisms?
- Where are helpful micro-organisms found?

Materials

- resources on micro-organisms
- computers with Internet access
- speakers

Procedure

To begin this learning experience students should be given the opportunity to share what they know about helpful and harmful micro-organisms. Students should be given the opportunity to research topics such as

- controlling harmful micro-organisms
- helpful micro-organisms in food processing
- technology and micro-organisms
- micro-organisms in our homes

Students could present their findings in the form of posters, written papers, skits, or oral presentations, to name a few.

Activity 54: Structural Features of Organisms

Outcome

Students will be expected to

- propose questions and gather information about the relationship among the structural features of plants and animals in their environments and identify the positive and negative impacts of humans on these resources (204-1, 108-8)

Assessment

- Students are able to demonstrate an understanding of structural features of an organism in relationship to the environment in which it lives.
- Students are able to observe and record structural features of organisms in a local habitat.

Questions

- How do structural features of an organism help it to survive in the environment in which it lives?
- What is meant by the term **structural features**?

Materials

- hand-held magnifiers
- attribute rings or hoops
- clipboards
- reference materials
- computers with Internet access
- Activity 54: Structural Features of Organisms, My Investigations

Procedure

Part 1: Review with students the types of organisms they found in their local habitat. Discuss with them the term **structural features**. Develop a working definition for the term and post it in the classroom. Have students revisit the habitat they observed earlier in this unit (Activity 43). Have them look for organisms and record the structural features of the organisms. Have students discuss how the structural features help the organism to survive.

Part 2: Have students research an organism, where it lives, and the relationship of its structural features and the environment it lives in.

Activity 54: Structural Features of Organisms, My Investigations

Structural Features of Organisms in a Local Habitat

Organism	Structural Features	Where It Was Found

How were the structural features of the organism influenced by the environment in which it was found?

What is meant by the term **structural features**?

Illustration of one of the organisms. Label the structural features you observed.

Activity 55: Endangered Species

Outcome

Students will be expected to

- propose questions and gather information about the relationship among the structural features of plants and animals in their environments and identify the positive and negative impacts of humans on these resources (204-1, 108-8)

Assessment

- Students are able to demonstrate an understanding of the term **endangered species** through oral and written communication.
- Students are able to explain the importance of the continued existence of endangered species.

Questions

- What does the term **endangered species** mean?
- How have humans helped to prevent species from becoming endangered?
- How have humans caused certain animals to become endangered?

Materials

- reference resources
- computers with Internet access

Procedure

Through this learning experience, students should develop an understanding of respecting animals and their habitat. Discussions should begin with developing an understanding of the term **endangered** and how it relates to animals. Students should be given the opportunity to discuss animals that they think are endangered and look at their local habitat or province to see if there are any animals on the endangered list.

Allow students to choose an endangered animal to research, focussing on the habitat it needs to survive, what has caused it to become endangered, and how it can be saved from extinction. Students could be given the choice as to how they want to present their findings to the class.

Activity 56: Paleontologists

Outcome

Students will be expected to

- identify changes in animals over time and research and model the work of scientists (107-11, 207-4, 301-16)

Assessment

- Students are able to demonstrate the role of a paleontologist through written and hands-on experiences.

Questions

- What does a paleontologist do/study?
- How does the work of a paleontologist help us to understand the past in relation to plants and animals?

Materials

- reference books
- computers with Internet access
- plaster of Paris
- Plasticine

Procedure

The research portion of this learning experience could be done as part of the English language arts program. Students should research the changes in tools and techniques that paleontologists use to study forms of life that existed in the past. Students should also develop an understanding of what a paleontologist does.

Students could be given the opportunity to make their own fossils using Plasticine or plaster of Paris and excavate the fossils.

Appendix I: Print Resources

Authorized Learning Resources

The following resources to support teaching and learning in science are currently available through the Nova Scotia School Book Bureau (NSSBB). The NSSBB number is given in parentheses. Many of the following titles were sent to schools as part of the Active Young Readers initiative. Several of the titles are packaged sets of individual titles that have information texts related to the units of study in Science 6. For more details and title annotations, visit the NSSBB website at <https://w3apps.EDnet.ns.ca/nssbb>.

DK Eye Wonder Series (17519–17530)

Exploring Electricity (13683)

Inquisitive Green Level (13802)

Mainsails, Grade 4 (16689)

Mainsails, Grade 5 (16690)

Mainsails, Grade 6 (16691)

National Geographic Reading Expeditions (13497–13502)

National Geographic Reading Expeditions, Language, Literacy and Vocabulary! Physical Science, Complete Kit (17034)

National Geographic: Windows on Literacy Fluent Plus (13610)

National Geographic: Windows on Literacy Fluent Plus, Science Classroom Set (13646)

Nature: Animals, Planets and Birds in New Brunswick, Nova Scotia and Prince Edward Island (17506)

Planet Earth (16444)

Power Magazine Introductory Package, Grade 4 (16687)

Power Magazine Introductory Package, Grade 5 (16688)

Power Magazine Introductory Package, Grade 6 (16766)

Sci-Tech Connections 6 (17027)

Space Station (13525)

The News II Library Pack [Delisted; may be found in many classrooms.]

Professional Resources

Make It Real (16890)

Non-Fiction Craft Lessons, Teaching Information Writing K–8 (13623)

Show Me! Teaching Information and Visual Texts, Grades 5–6 (13153)

Appendix J:

Pan-Canadian Outcomes Chart

The following outcomes are from *Common Framework of Science Learning Outcomes K to 12* (Council of Ministers of Education, Canada, 1997) that were used as guidelines for this science document; column one outcomes were developed from these pan-Canadian outcomes.

Physical Science: Electricity

STSE	Skills	Knowledge
<p><i>Students will be expected to</i></p> <p>Nature of Science and Technology</p> <p>104-5 describe how results of similar and repeated investigations may vary and suggest possible explanations for variations</p> <p>105-3 describe examples of scientific questions and technological problems that have been addressed differently at different times</p> <p>Relationships between Science and Technology</p> <p>106-3 describe examples of improvements to the tools and techniques of scientific investigation that have led to new discoveries</p> <p>106-4 describe instances where scientific ideas and discoveries have led to new inventions and applications</p>	<p><i>Students will be expected to</i></p> <p>Initiating and Planning</p> <p>204-1 propose questions to investigate and practical problems to solve</p> <p>204-3 state a prediction and a hypothesis based on an observed pattern of events</p> <p>204-7 plan a set of steps to solve a practical problem and to carry out a fair test of a science-related idea</p> <p>204-8 identify appropriate tools, instruments, and materials to complete their investigations</p> <p>Performing and Recording</p> <p>205-3 follow a given set of procedures</p> <p>205-9 use tools and apparatus in a manner that ensures personal safety and the safety of others</p>	<p><i>Students will be expected to</i></p> <p>300-20 compare the conductivity of a variety of solids and liquids</p> <p>303-22 compare the characteristics of static and current electricity</p> <p>303-23 compare a variety of electrical pathways by constructing simple circuits</p> <p>303-24 describe the role of switches in electrical circuits</p> <p>303-25 compare characteristics of series and parallel circuits</p> <p>303-26 demonstrate how electricity in circuits can produce light, heat, sound, motion, and magnetic effects</p> <p>303-27 describe the relationship between electricity and magnetism when using an electromagnet</p> <p>303-28 identify various methods by which electricity can be generated</p>

Physical Science: Electricity (*cont'd*)

STSE	Skills	Knowledge
<p><i>Students will be expected to</i></p> <p>Social and Environmental Contexts of Science and Technology</p> <p>107-9 compare past and current needs and describe some ways in which science and technology have changed the way people work, live, and interact with the environment</p> <p>108-2 describe intended and unintended effects of a scientific or technological development</p> <p>108-5 describe how personal actions help conserve natural resources and protect the environment in their region</p> <p>108-8 describe the potential impact of the use by humans of regional natural resources</p>	<p><i>Students will be expected to</i></p> <p>Analysing and Interpreting</p> <p>206-5 draw a conclusion, based on evidence gathered through research and observation, that answers an initial question</p> <p>Communication and Teamwork</p> <p>207-2 communicate procedures and results, using lists, notes in point form, sentences, charts, graphs, drawings, and oral language</p>	<p><i>Students will be expected to</i></p> <p>303-29 identify and explain sources of electricity as renewable or non-renewable</p> <p>303-30 identify and explain different factors that could lead to a decrease in electrical energy consumption in the home and at school</p> <p>303-31 identify and explain the dangers of electricity at work or at play</p>

Physical Science: Flight

STSE	Skills	Knowledge
<p><i>Students will be expected to</i></p> <p>Nature of Science and Technology</p> <p>104-3 demonstrate and explain the importance of selecting appropriate processes for investigating scientific questions and solving technological problems</p> <p>105-3 describe examples of scientific questions and technological problems that have been addressed differently at different times</p> <p>Relationships between Science and Technology</p> <p>106-3 describe examples of improvements to the tools and techniques of scientific investigation that have led to new discoveries</p> <p>Social and Environmental Contexts of Science and Technology</p> <p>107-9 compare past and current needs and describe some ways in which science and technology have changed the way people work, live, and interact with the environment</p>	<p><i>Students will be expected to</i></p> <p>Initiating and Planning</p> <p>204-7 plan a set of steps to solve a practical problem and to carry out a fair test of a science-related idea</p> <p>Performing and Recording</p> <p>205-5 make observations and collect information that is relevant to a given question or problem</p> <p>Analysing and Interpreting</p> <p>206-6 suggest improvements to a design or constructed object</p>	<p><i>Students will be expected to</i></p> <p>300-21 identify characteristics and adaptations that enable birds and insects to fly</p> <p>300-22 describe and justify the differences in design between aircraft and spacecraft</p> <p>301-17 describe and demonstrate how life is affected by the shape of a surface</p> <p>301-18 describe and demonstrate methods for altering drag in flying devices</p> <p>303-32 describe the role of lift in overcoming gravity and enabling devices or living things to fly</p> <p>303-33 identify situations that involve Bernoulli's principle</p> <p>303-34 describe the means of propulsion for flying devices</p>

Earth and Space Science: Space

STSE	Skills	Knowledge
<p><i>Students will be expected to</i></p> <p>Nature of Science and Technology</p> <p>104-8 demonstrate the importance of using the languages of science and technology to compare and communicate ideas, processes, and results</p> <p>105-6 describe how evidence must be continually questioned in order to validate scientific knowledge</p> <p>Relationships between Science and Technology</p> <p>106-3 describe examples of improvements to the tools and techniques of scientific investigation that have led to new discoveries</p> <p>Social and Environmental Contexts of Science and Technology</p> <p>107-3 compare tools, techniques, and scientific ideas used by different people around the world to interpret natural phenomena and meet their needs</p> <p>107-15 describe scientific and technological achievements that are the result of contributions by people from around the world</p>	<p><i>Students will be expected to</i></p> <p>Performing and Recording</p> <p>205-2 select and use tools in manipulating materials and in building models</p> <p>205-8 identify and use a variety of sources and technologies to gather pertinent information</p> <p>Analysing and Interpreting</p> <p>206-4 evaluate the usefulness of different information sources in answering a given question</p> <p>206-5 draw a conclusion, based on evidence gathered through research and observation, that answers an initial question</p> <p>Communication and Teamwork</p> <p>207-2 communicate procedures and results, using lists, notes in point form, sentences, charts, graphs, drawings, and oral language</p>	<p><i>Students will be expected to</i></p> <p>300-23 describe the physical characteristics of components of the solar system—specifically, the sun, planets, moons, comets, asteroids, and meteors</p> <p>301-19 demonstrate how Earth’s rotation causes the day and night cycle and how Earth’s revolution causes the yearly cycle of seasons</p> <p>301-20 observe and explain how the relative positions of Earth, the moon, and the sun are responsible for the moon phases, eclipses, and tides</p> <p>301-21 describe how astronauts are able to meet their basic needs in space</p> <p>302-13 identify constellations in the night sky</p>

Life Science: Diversity of Life

STSE	Skills	Knowledge
<p><i>Students will be expected to</i></p> <p>Nature of Science and Technology</p> <p>104-5 describe how results of similar and repeated investigations may vary and suggest possible explanations for variations</p> <p>Social and Environmental Contexts of Science and Technology</p> <p>107-3 compare tools, techniques, and scientific ideas used by different people around the world to interpret natural phenomena and meet their needs</p> <p>107-6 provide examples of how science and technology have been used to solve problems around the world</p> <p>107-11 identify examples of careers in which science and technology play a major role</p> <p>108-8 describe the potential impact of the use by humans of regional natural resources</p>	<p><i>Students will be expected to</i></p> <p>Initiating and Planning</p> <p>204-1 propose questions to investigate and practical problems to solve</p> <p>204-6 identify various methods for finding answers to given questions and solutions to given problems and select one that is appropriate</p> <p>204-8 identify appropriate tools, instruments, and materials to complete their investigations</p> <p>Performing and Recording</p> <p>205-8 identify and use a variety of sources and technologies to gather pertinent information</p> <p>Analysing and Interpreting</p> <p>206-1 classify according to several attributes and create a chart or diagram that shows the method of classifying</p> <p>206-9 identify new questions or problems that arise from what was learned</p> <p>Communication and Teamwork</p> <p>207-4 ask others for advice or opinions</p>	<p><i>Students will be expected to</i></p> <p>300-15 describe the role of a common classification system for living things</p> <p>300-16 distinguish between vertebrates and invertebrates</p> <p>300-17 compare the characteristics of mammals, birds, reptiles, amphibians, and fishes</p> <p>300-18 compare characteristics of common arthropods</p> <p>300-19 examine and describe some living things that cannot be seen with the naked eye</p> <p>301-15 compare the adaptations of closely related animals living in different parts of the world and discuss reasons for any differences</p> <p>301-16 identify changes in animals over time, using fossils</p> <p>302-12 describe how micro-organisms meet their basic needs, including obtaining food, water, and air and moving around</p>

